

Medical ultrasound imaging

Modern ultrasound imaging

André Sopczak

Institute of Experimental and Applied Physics,
Czech Technical University in Prague

<http://cern.ch/sopczak>

andre.sopczak@cvut.cz

based on lectures 2008-2023 by J.Kybic,
using plots by J.Hornak¹, E.Dove, P.Stoyen

2024

¹<http://www.cis.rit.edu/htbooks/mri/>

Doppler ultrasound

US contrast agents

Harmonic imaging

3D US imaging

Christian Doppler

1803–1853



During his time in Prague as a professor he married and had five children, whilst he published over 50 articles on mathematics, physics and astronomy. In 1842 he published his most famous paper *Über das farbige Licht der Doppelsterne* (“Concerning the Colored Light of Double Stars”), which contained his first statement of the Doppler effect.

Doppler frequency shift

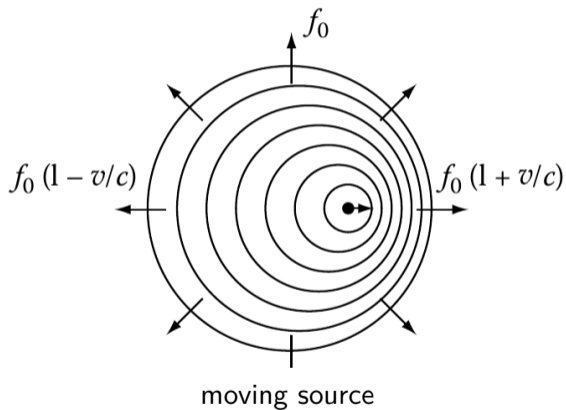
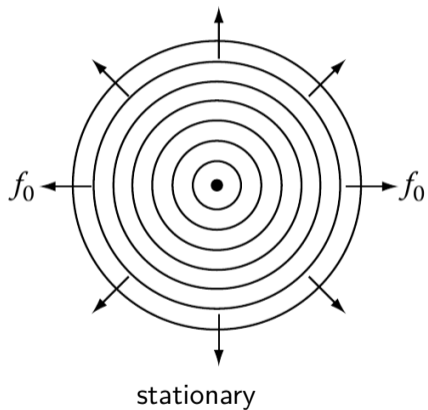

Stationary source, moving receiver

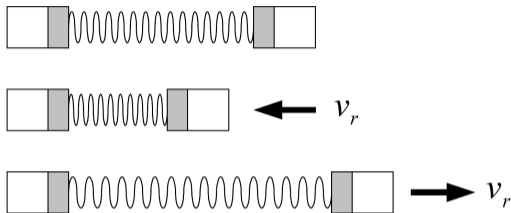

$$f_r = f_s + \frac{v_r}{\lambda_s} = f_s + \frac{v_r}{c} f_s = f_s + f_d, \quad \text{since } \lambda_s = \frac{c}{f_s}$$

Doppler shift

$$f_d = \frac{v_r}{c} f_s$$

Stationary source, moving receiver

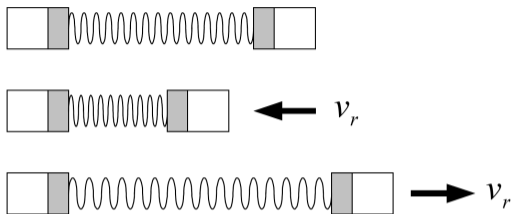

$$f_r = f_s + \frac{v_r}{\lambda_s} = f_s + \frac{v_r}{c} f_s = f_s + f_d, \quad \text{since } \lambda_s = \frac{c}{f_s}$$

Doppler shift

$$f_d = \frac{v_r}{c} f_s$$

Example: For $f = 5 \text{ MHz}$, $v_r = 1 \text{ cm/s}$, $f_d = 33 \text{ Hz}$.

Stationary receiver, moving source

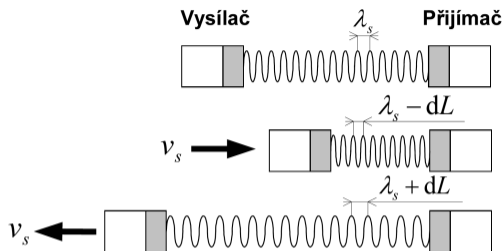

Wavelength change

$$\delta\lambda = v_s T_s = \frac{v_s}{f_s}$$

$$\lambda_r = \lambda_s - \delta\lambda = \frac{c}{f_s} - \frac{v_s}{f_s}$$

$$f_r = \frac{c}{\lambda_r} = \frac{c}{c - v_s} f_s$$

Stationary receiver, moving source (2)

$$f_r = \frac{c}{\lambda_r} = \frac{c}{c - v_s} f_s = \frac{1}{1 - \frac{v_s}{c}} f_s$$

Stationary receiver, moving source (2)

$$f_r = \frac{c}{\lambda_r} = \frac{c}{c - v_s} f_s = \frac{1}{1 - \frac{v_s}{c}} f_s$$

From Taylor series, for $x \ll 1$

$$\frac{1}{1 - x} = 1 + x + \frac{x^2}{2} + \dots \approx 1 + x$$

For $v \ll c$

$$f_r \approx \left(1 + \frac{v_s}{c}\right) f_s = f_s + f_d$$

Doppler shift

$$f_d = \frac{v_s}{c} f_s$$

Blood flow speed measurement

- ▶ Doppler effect: Frequency changes if the source moves with respect to the receiver.
- ▶ Reflection from red blood cells
- ▶ Red blood cells
 - ▶ Moving receiver
 - ▶ Moving source
- ▶ Doppler shift

$$f_r = f_t + f_d$$

$$f_d \approx 2 \frac{v}{c} f_c$$

Moving scatterer

time and frequency domains

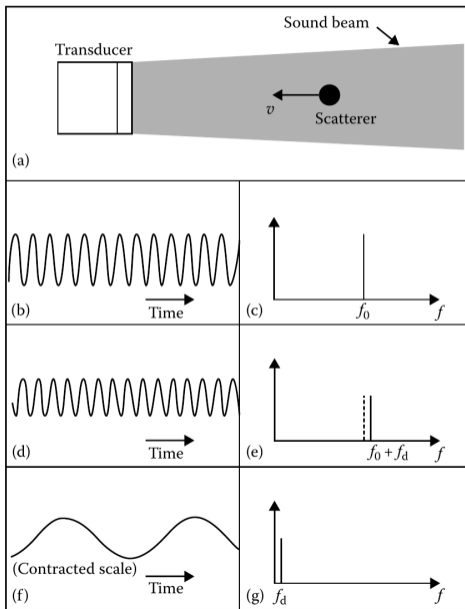

Angle dependency

We only measure the projection along the ray: $v \cos \theta$

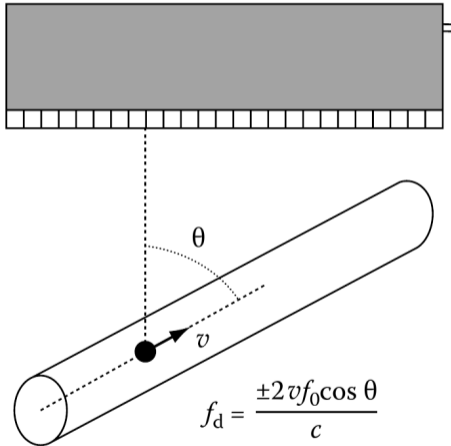

$$f_d = \frac{\pm 2vf_0 \cos \theta}{c}$$

$$f_0 = f_s$$

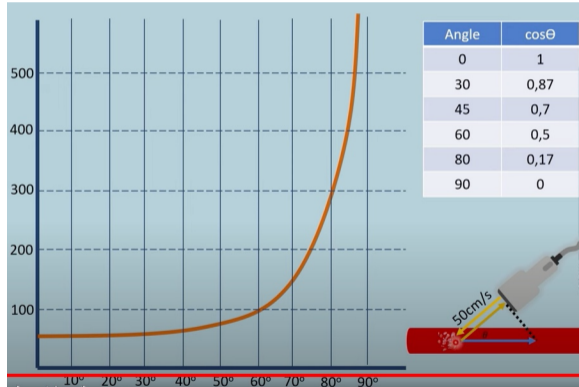

Angle dependency (2)

- ▶ Insonation angle 90° \rightarrow weak or no signal.
- ▶ Known angle \rightarrow angle correction.

Continuous wave Doppler

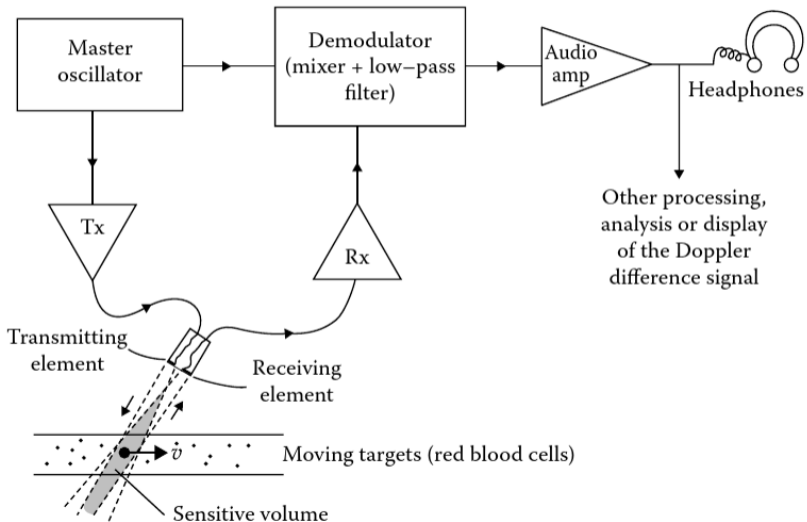

Quadrature detector

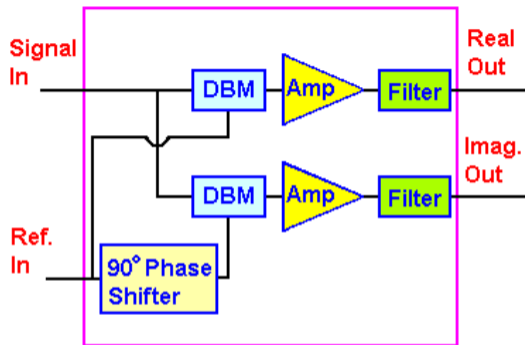

- ▶ *Input:* $g_a = \cos(at)$, $g_b = \cos(bt)$
- ▶ *Output:* $g = g_a g_b = \frac{1}{2} \cos((a+b)t) + \frac{1}{2} \cos((a-b)t)$
- ▶ Signal $\cos((a+b)t)$ can be filtered (low-pass filter)
- ▶ Difference frequency signal $s_r = \cos((a-b)t)$
- ▶ “Imaginary” signal s_i shifted by 90° : $\sin((a-b)t)$

Directional demodulation

To distinguish positive/negative flow direction, $\pm f_d$.

Method 1: Phase-domain processing

- ▶ Quadrature mixer with f_s
- ▶ Phase offset $\angle s_r = \angle s_i = \pm 90^\circ$

	$f_d > 0$	$f_d < 0$
$s_r + T_{90}s_i$	0	$2s_r$
$T_{90}s_r + s_i$	$2s_r$	0

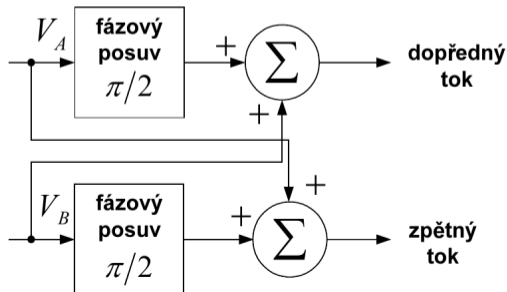

Directional demodulation

To distinguish positive/negative flow direction, $\pm f_d$.

Method 2: Frequency shift

- ▶ Quadrature mixer with $f_s + f_o$
- ▶ $f_d = 0 \rightarrow$ mixer output f_o
- ▶ $f_d = \text{freq}(s_r) - f_o$

Pulsed wave Doppler

(PW)

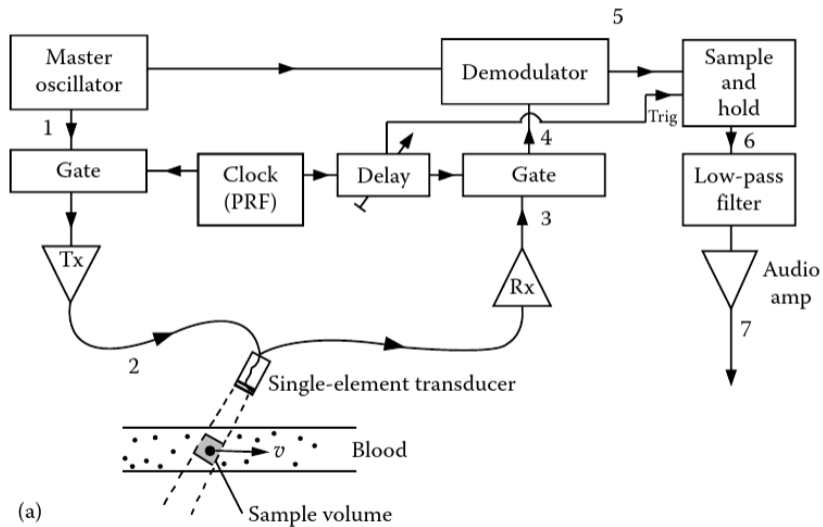

Sampled Doppler shift signal

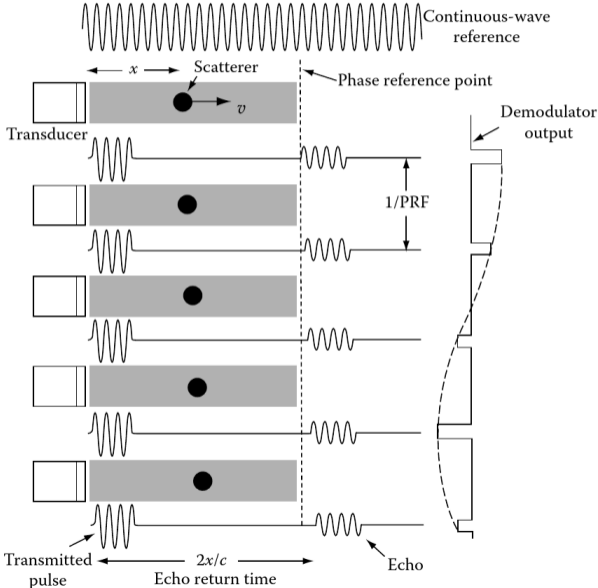

PW Doppler shift signals

Point on diagram

Signal representation at this point

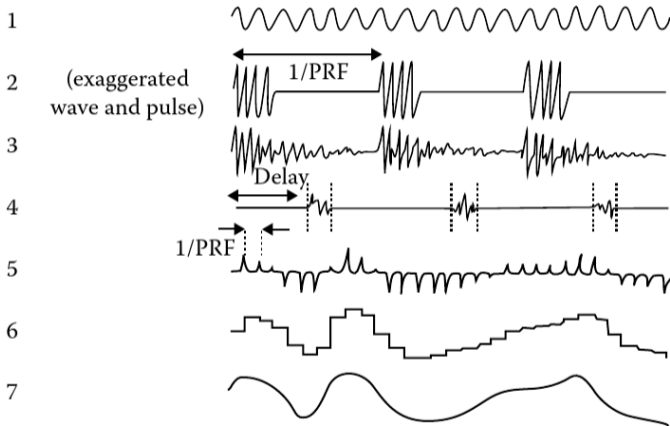

PRF: pulse repetition frequency, 2: transmitted signal, 3: received signal, 4: gated signal, 5: demodulated signal, 6: interpolated signal, 7: output

PW Doppler spectrum

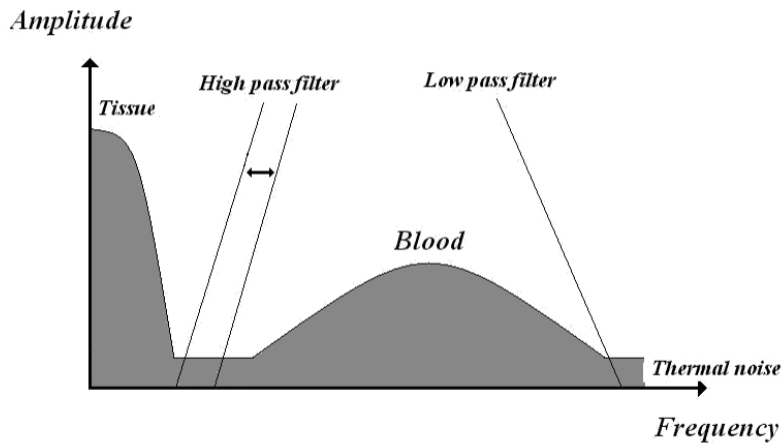

Speed uncertainty

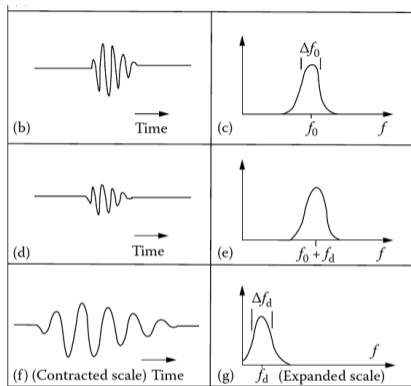

$$\Delta f_d = \frac{2v}{c\tau} = \frac{f_d}{\underbrace{f_s \tau}_Q}, \quad \Delta v = \frac{v}{Q}$$

τ — pulse length, Q — quality factor, number of cycles in a pulse

Speed uncertainty

Angle dependency

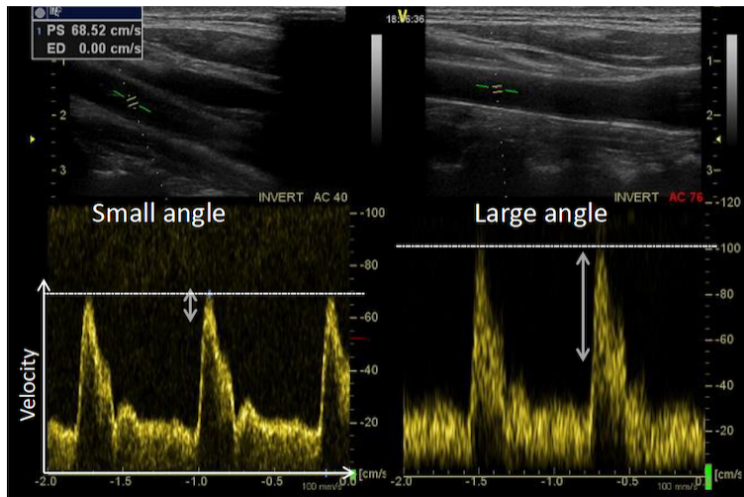

small angle \rightarrow higher number of cycles Q

Aliasing (PRF too low)

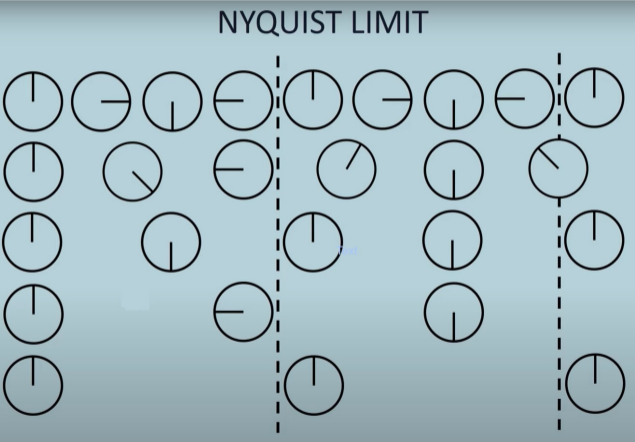
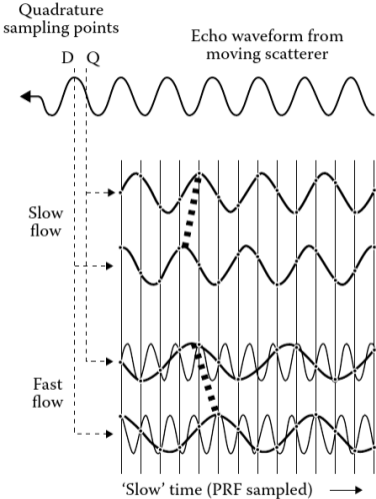

Nyquist → $f_d < f_p/2$

Aliasing example

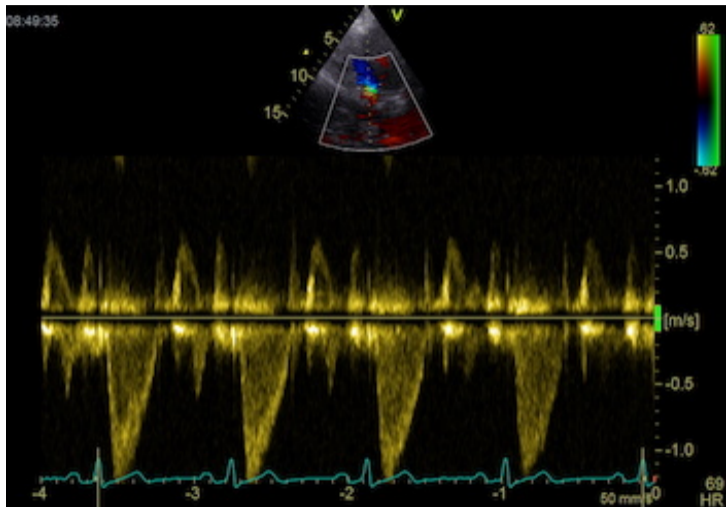

B-mode+Doppler+velocity spectrum — high PRF f_p

Aliasing example

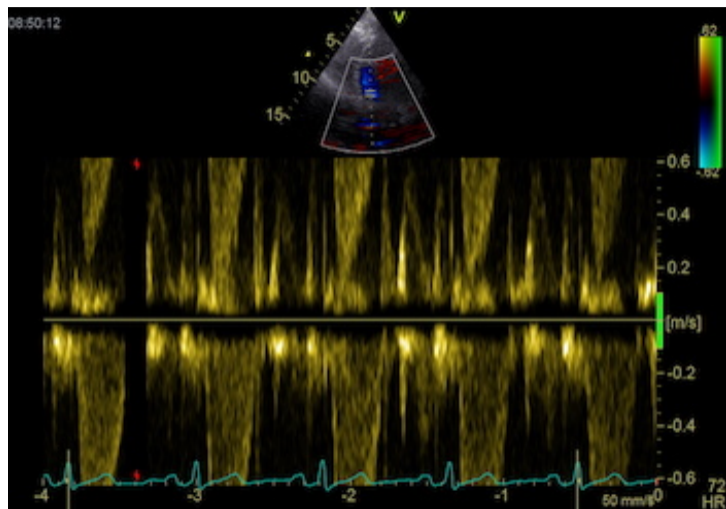

spectrum — low PRF f_p

Range-velocity tradeoff

$$f_d < f_p/2 \quad \longrightarrow \quad v_{\max} = \frac{f_p c}{4f_s}$$

$$z_{\max} = \frac{T_p c}{2} = \frac{c}{2f_p}$$

$$v_{\max} z_{\max} = \frac{c^2}{8f_s}$$

Range-velocity tradeoff

$$f_d < f_p/2 \quad \longrightarrow \quad v_{\max} = \frac{f_p c}{4f_s}$$

$$z_{\max} = \frac{T_p c}{2} = \frac{c}{2f_p}$$

$$v_{\max} z_{\max} = \frac{c^2}{8f_s}$$

Limitation is for $(v \cos \theta)_{\max}$.

Range-velocity tradeoff

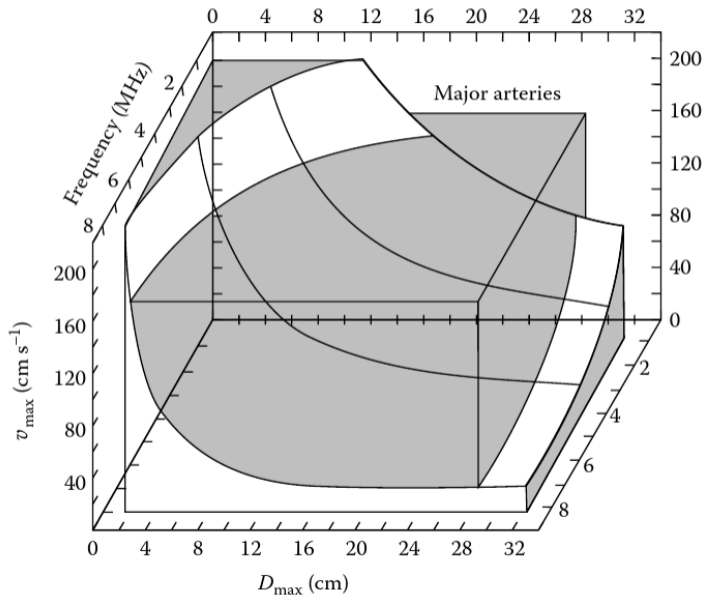

Minimum velocity

Observe at least one period of f_d

$$T_d < NT_p$$

with N transmissions per line

$$f_d > \frac{f_p}{N}$$
$$v_{\min} = \frac{f_p c}{2Nf_s}$$

Minimum velocity

Observe at least one period of f_d

$$T_d < NT_p$$

with N transmissions per line

$$f_d > \frac{f_p}{N}$$
$$v_{\min} = \frac{f_p c}{2Nf_s}$$

- ▶ Usually 2 ~ 3 cycles required
- ▶ $N = 5 \sim 10$ or more
- ▶ Temporal averaging
- ▶ \rightarrow slow f_p

Doppler US — examples

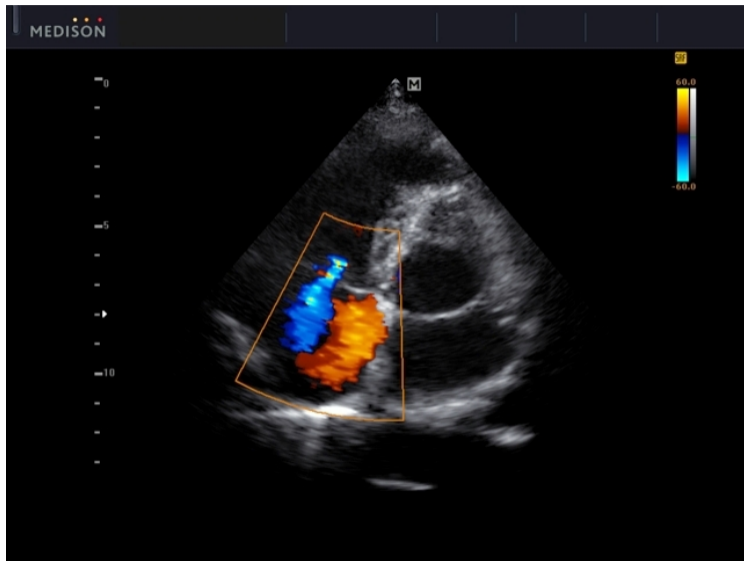

heart

Doppler US — examples

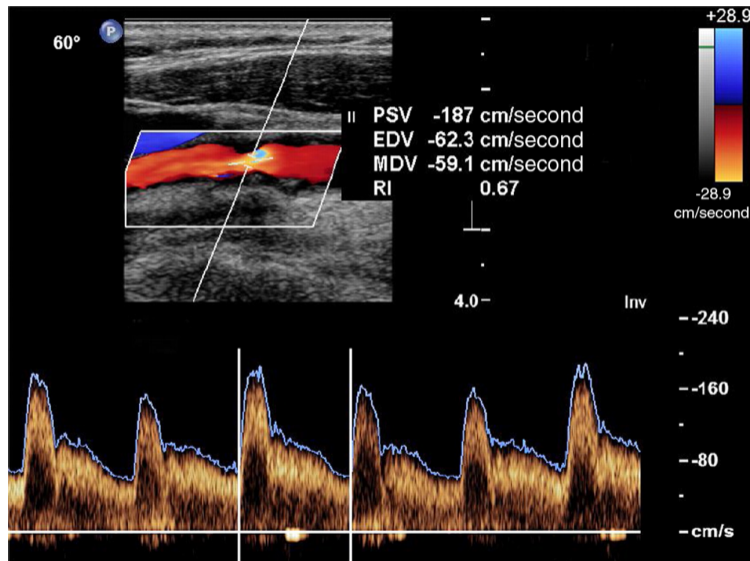

artery

Doppler US — examples

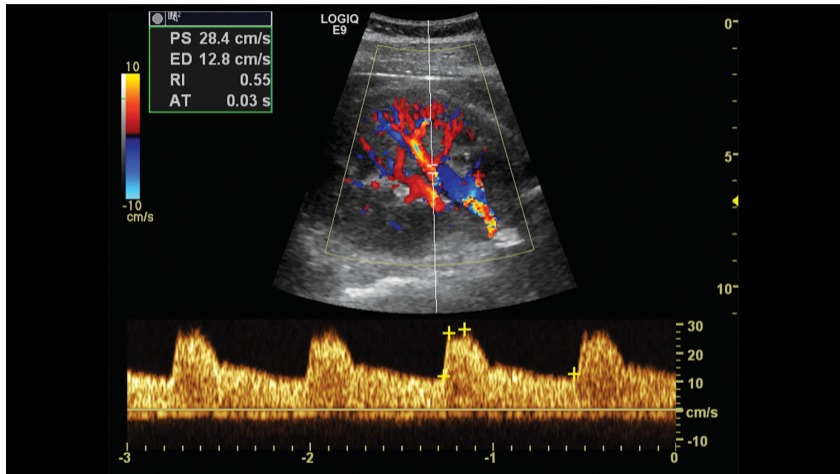

liver

Doppler ultrasound

US contrast agents

Harmonic imaging

3D US imaging

Contrast agents

- ▶ *1968, Gramiak, saline injection*
- ▶ Microbubbles ($2 \sim 5 \mu\text{m}$)
- ▶ Asymmetric compression/expansion
- ▶ Stabilization (synthetic polymers), up to 5 – 10 min.
- ▶ Injection
- ▶ Albunex, Optison, Echovist, Levovist. . .

Flash contrast imaging

US bubble destabilization.



normal

Flash contrast imaging

US bubble destabilization.



flash, bubbles broken

Flash contrast imaging

US bubble destabilization.



filling up

Myocardial perfusion evaluation.

Doppler ultrasound

US contrast agents

Harmonic imaging

3D US imaging

Nonlinear response

Assymmetric bubble compression

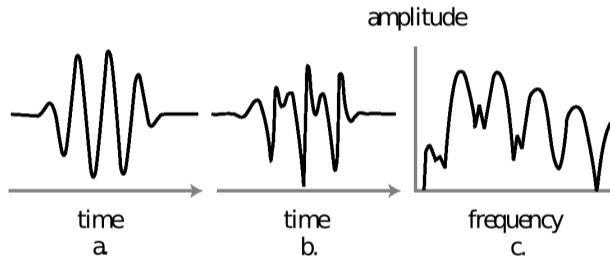

Harmonic imaging

- ▶ Transmit f_0 , receive $2f_0$

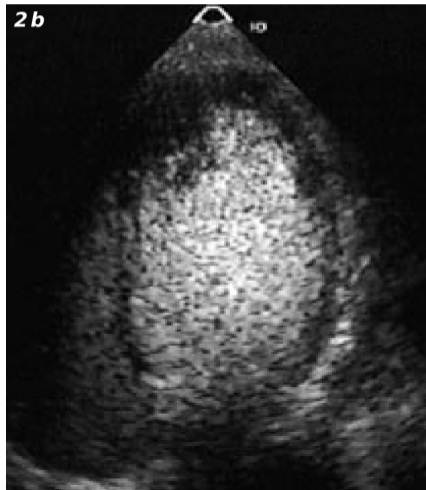

Harmonic imaging

- ▶ Transmit f_0 , receive $2f_0$
- ▶ Bandwidth limitation
- ▶ Bubbles not needed, tissue nonlinearity

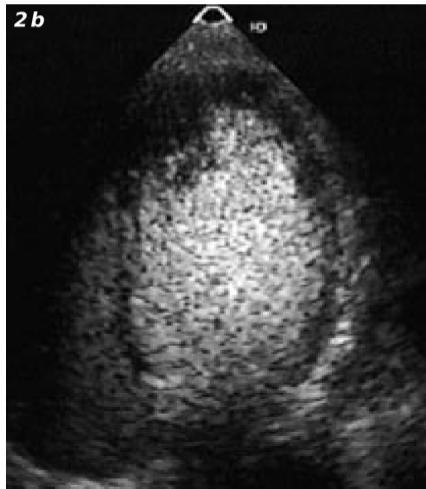

Pulse Inversion Harmonic Imaging

- ▶ Two pulses, second inverted
- ▶ Responses summed
- ▶ Filtration not needed

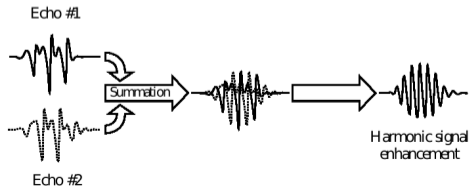
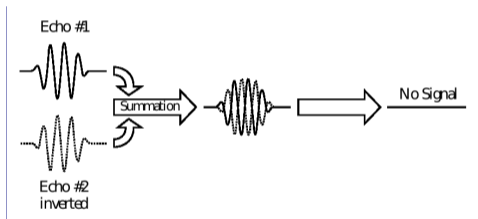

Pulse Inversion Harmonic Imaging

- ▶ Two pulses, second inverted
- ▶ Responses summed
- ▶ Filtration not needed

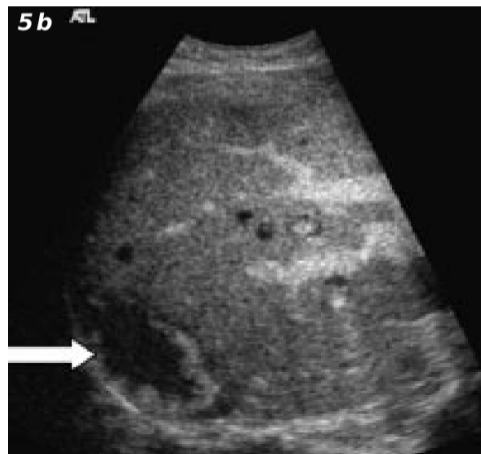
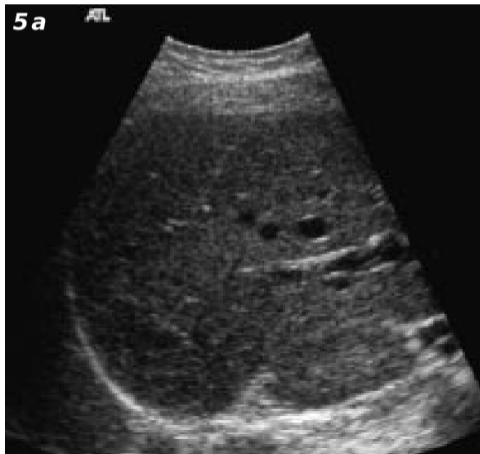

Pulse Inversion Harmonic Imaging

- ▶ Two pulses, second inverted
- ▶ Responses summed
- ▶ Filtration not needed
- ▶ Several pulses (Power Pulse Inversion)

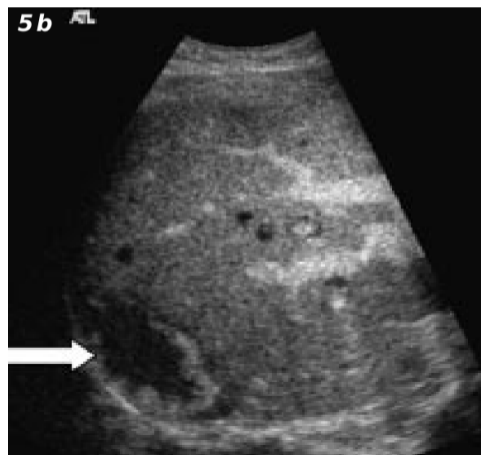
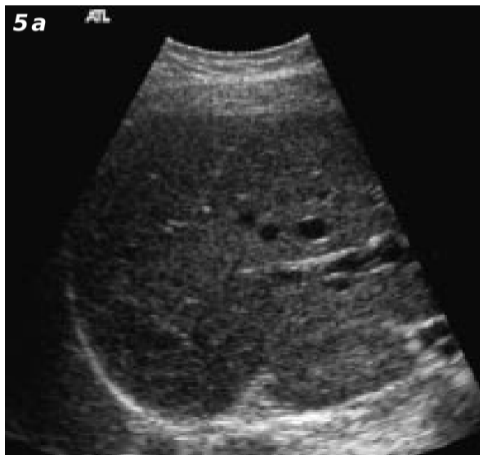

Doppler ultrasound

US contrast agents

Harmonic imaging

3D US imaging

3D Reconstruction



3D Ultrasound

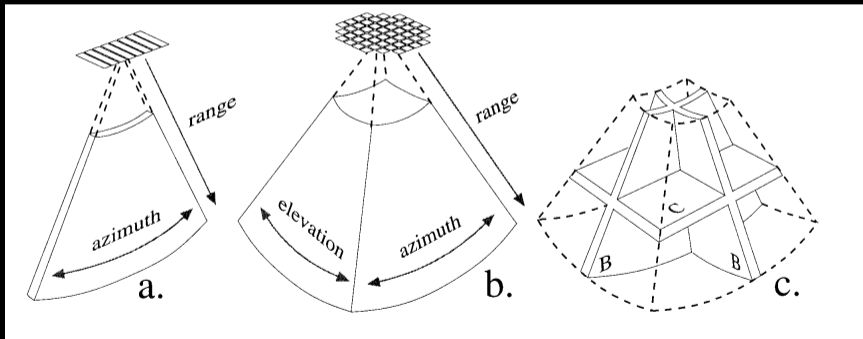

Traditional 2D

New 3D

Real-time 3D Ultrasound

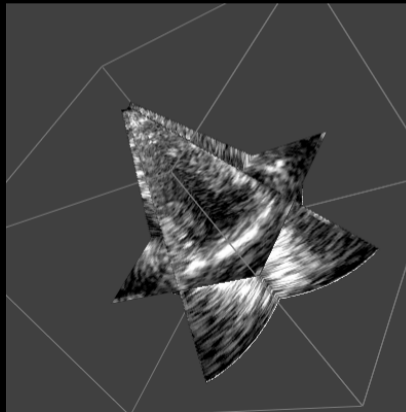
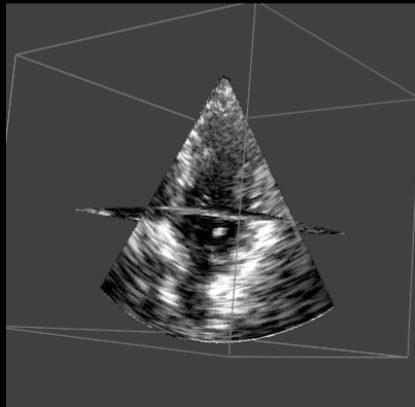

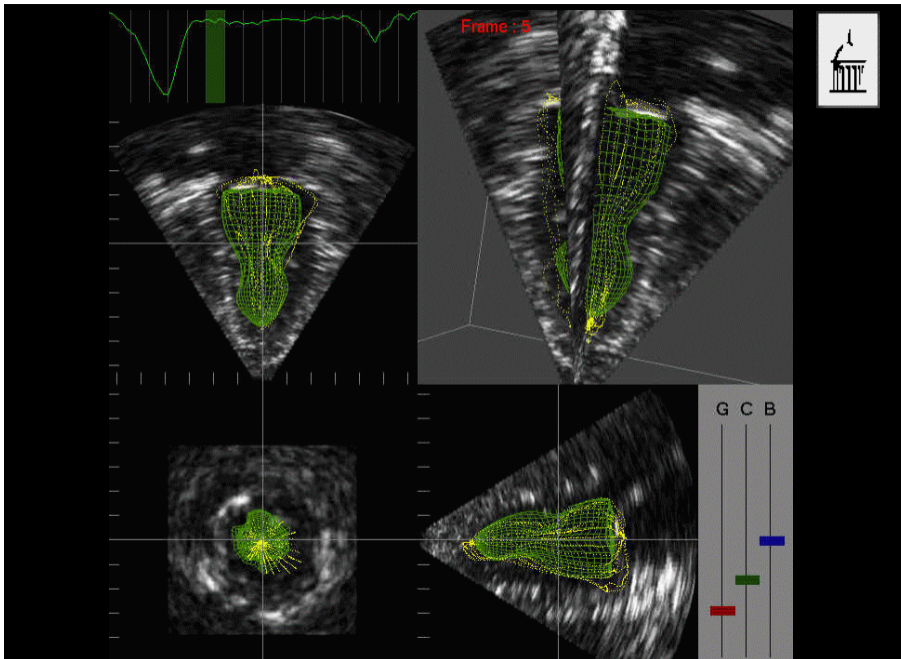

Frame : 5

G C B

Velocity of Contraction

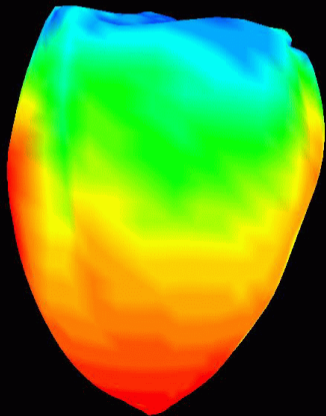

N 1

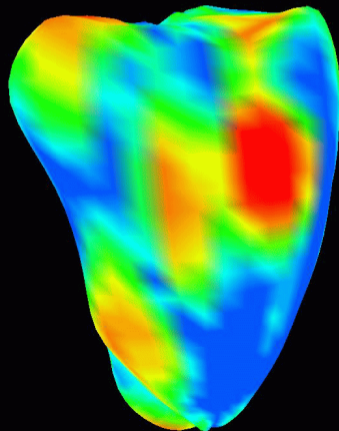

A 1

Biological effects

- ▶ Thermal effects
 - ▶ 1.5 °C indefinitely or 6 °C for 1 min
 - ▶ highest risk in bones (transcranial imaging)
- ▶ Cavitation — growth/collapse of bubbles
 - ▶ for long pulse lengths or high pressure
 - ▶ may damage cells
 - ▶ unlikely to occur *in vivo*
- ▶ Radiation pressure — makes tissues/fluids move

Biological effects

- ▶ Thermal effects
 - ▶ 1.5 °C indefinitely or 6 °C for 1 min
 - ▶ highest risk in bones (transcranial imaging)
- ▶ Cavitation — growth/collapse of bubbles
 - ▶ for long pulse lengths or high pressure
 - ▶ may damage cells
 - ▶ unlikely to occur *in vivo*
- ▶ Radiation pressure — makes tissues/fluids move
- ▶ Clinical studies found no harmful effects

Biological effects

- ▶ Thermal effects
 - ▶ 1.5 °C indefinitely or 6 °C for 1 min
 - ▶ highest risk in bones (transcranial imaging)
- ▶ Cavitation — growth/collapse of bubbles
 - ▶ for long pulse lengths or high pressure
 - ▶ may damage cells
 - ▶ unlikely to occur *in vivo*
- ▶ Radiation pressure — makes tissues/fluids move
- ▶ Clinical studies found no harmful effects
- ▶ ... ultrasound power output is increasing.

Conclusions

- ▶ Non-invasive, affordable and portable imaging technique
- ▶ Excellent soft tissue imaging
- ▶ Lower image quality (wrt CT or MRI) due to speckle but improving
- ▶ Low penetration depth versus resolution
- ▶ Does not pass through air or gas
- ▶ Does not pass through bones, shadows
- ▶ Modern techniques — 3D, contrast agents, Doppler