



Sensors for humanoids and artificial skins

Doc. Mgr. Matěj Hoffmann, Ph.D.

Department of Cybernetics, Faculty of Electrical Engineering

Czech Technical University in Prague

matej.hoffmann@fel.cvut.cz

<https://sites.google.com/site/matejhof>

<https://cyber.felk.cvut.cz/research/groups-teams/humanoids/>



Sensors in a robot manipulator - position

- Encoders

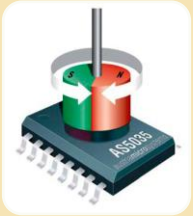

Position Sensors

- 45 Absolute Position Sensors in the joints (analog or digital hall effect sensor) (12 bits/turn)
- 20 optical encoders for DC motors (10 to 12 bits/turn)
- 11 Reflective Encoder on the ROTOR shaft of the BLDC Motors (about 12 bits/turn)

Marco Maggiali, iCub system architecture 2021

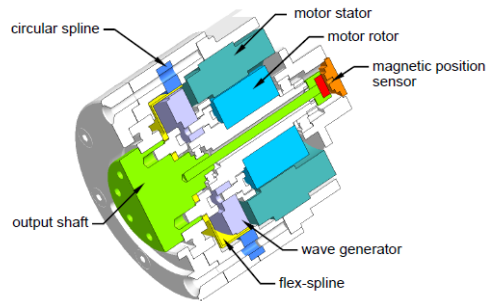
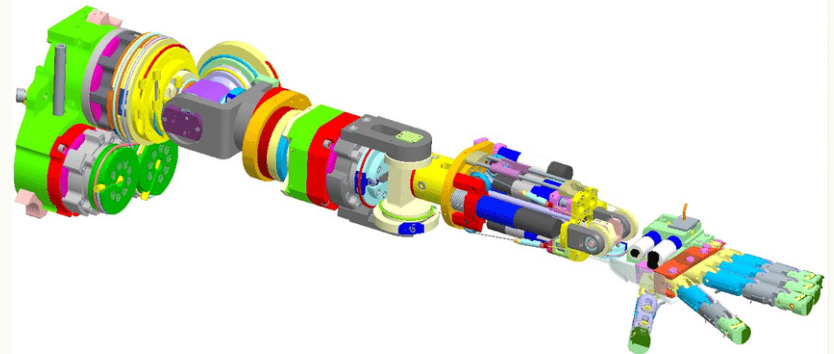

Fig. 3. Motor group cross section. The figure shows a cross section of a iCub motor group. The Harmonic-Drive and Kollmorgen brushless motor are clearly visible.

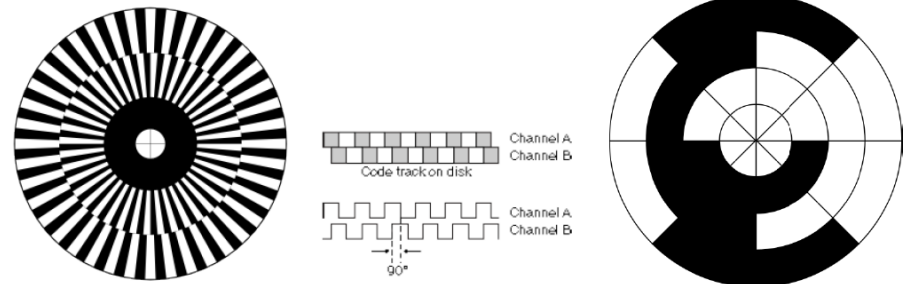

Figure 7.2. From left to right: encoder pattern used in a quadrature encoder, resulting sensor signal (forward motion), absolute encoder pattern (gray coding).

Correll, N., Hayes, B., Heckman, C., Roncone, A. (2022).

- What is it enough for?

Sensors in a manipulator – force / torque

- motor current – motor load
 - with complex modeling, joint torques and possibly ext. wrenches can be *coarsely* estimated
- force/torque sensor at the flange
- joint torque sensors
- force/torque sensor located proximally

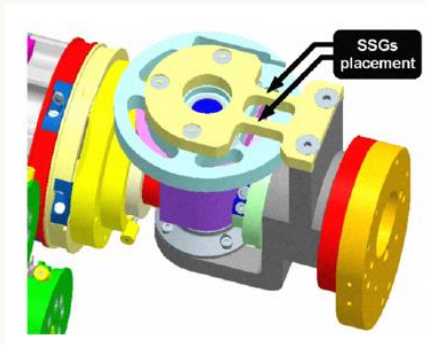
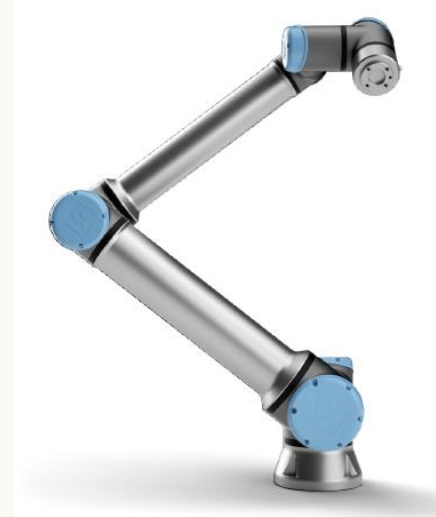

shoulder roll with semiconductor strain gauge

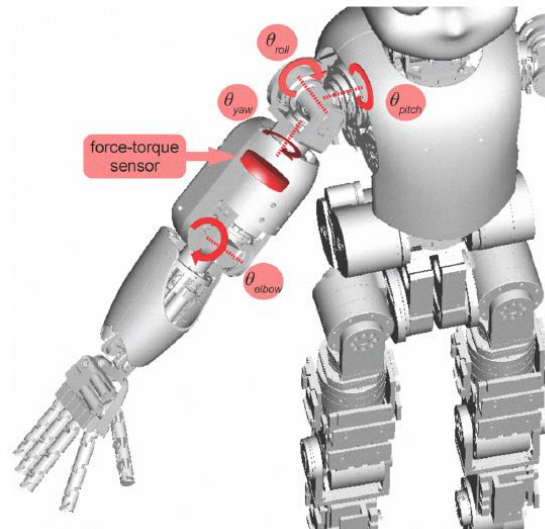

Discussion

Example – contact detection

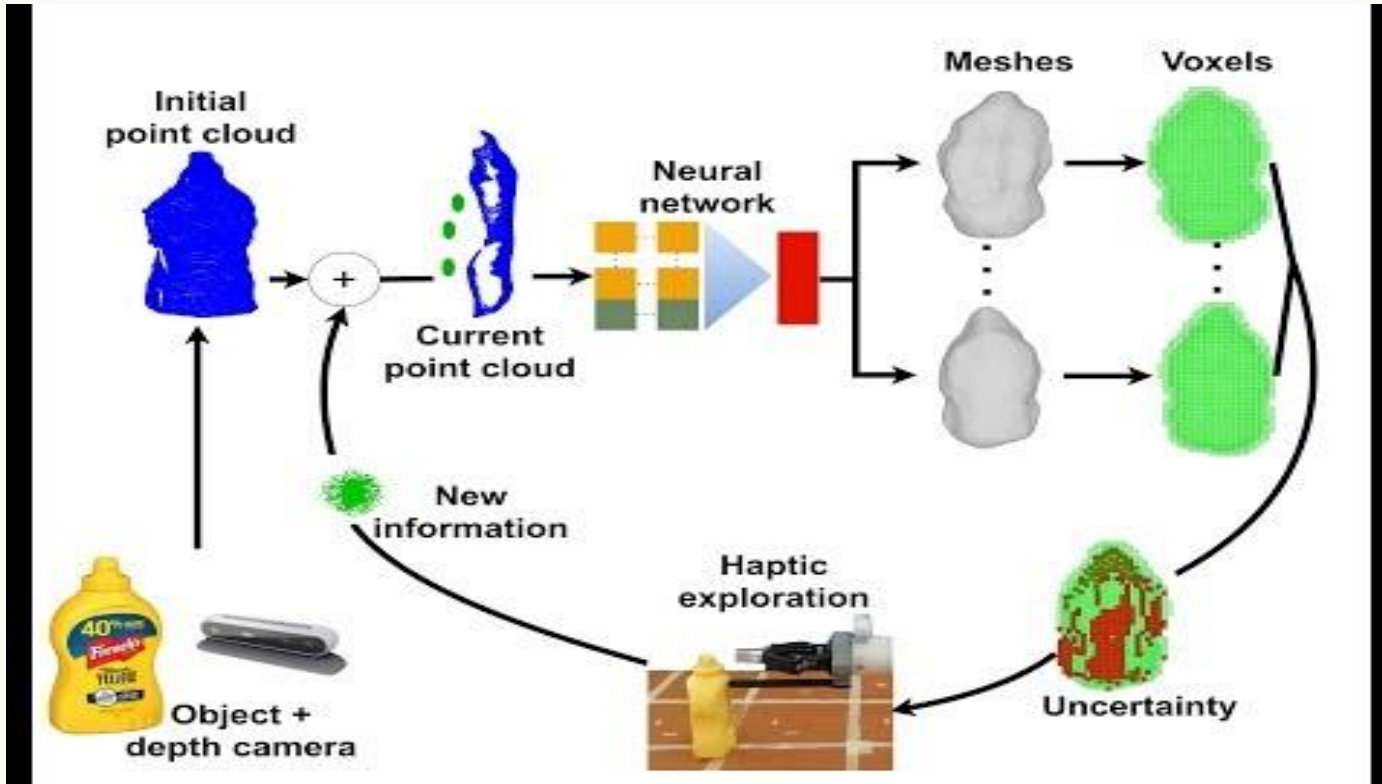

From 1:10 in
<https://youtu.be/iZF4ph4zMEA>

Rustler, L., Lundell, J., Behrens, J. K., Kyrki, V., & Hoffmann, M. (2022). 'Active Visuo-Haptic Object Shape Completion'. *IEEE Robotics and Automation Letters* 7 (2), 5254-5261.

External torque estimation



● joint torque sensors

$$\boldsymbol{\tau} = \boldsymbol{M}(\boldsymbol{q})\ddot{\boldsymbol{q}} + \boldsymbol{C}(\boldsymbol{q}, \dot{\boldsymbol{q}})\dot{\boldsymbol{q}} + \boldsymbol{g}(\boldsymbol{q}) + \boldsymbol{\tau}_F + \boldsymbol{\tau}_{ext} = \boldsymbol{\tau}_{dyn} + \boldsymbol{\tau}_{ext}$$

$\boldsymbol{M}(\boldsymbol{q}) \in \mathbb{R}^{n \times n}$ joint space inertia matrix

$\boldsymbol{C}(\boldsymbol{q}, \dot{\boldsymbol{q}})\dot{\boldsymbol{q}} \in \mathbb{R}^n$ centripetal and Coriolis vector

$\boldsymbol{g}(\boldsymbol{q}) \in \mathbb{R}^n$ gravity vector

$\boldsymbol{\tau} \in \mathbb{R}^n$ joint torque measured by sensor

$\boldsymbol{\tau}_{dyn} \in \mathbb{R}^n$ torque computed from dynamics

- results from the configuration, velocity and acceleration of the robot
- can be obtained with dynamics simulator (e.g. OpenRave)

$\boldsymbol{\tau}_F \in \mathbb{R}^n$ dissipative friction torque

$\boldsymbol{\tau}_{ext} \in \mathbb{R}^n$ external joint torque ($\boldsymbol{\tau}_{ext} = \boldsymbol{J}^T(\boldsymbol{q})\boldsymbol{\mathcal{F}}_{ext}$)

$$\boldsymbol{\tau}_{ext} = \boldsymbol{\tau} - \boldsymbol{\tau}_{dyn}$$

Humanoids have much more than that ...

- 53+ joint encoders
- 4 Force/Torque sensors
- 2 cameras
- tactile sensors
 - cca 4000 pressure-sensitive tactile elements (taxels) on the whole body
- inertial sensors (IMU)
- microphones...



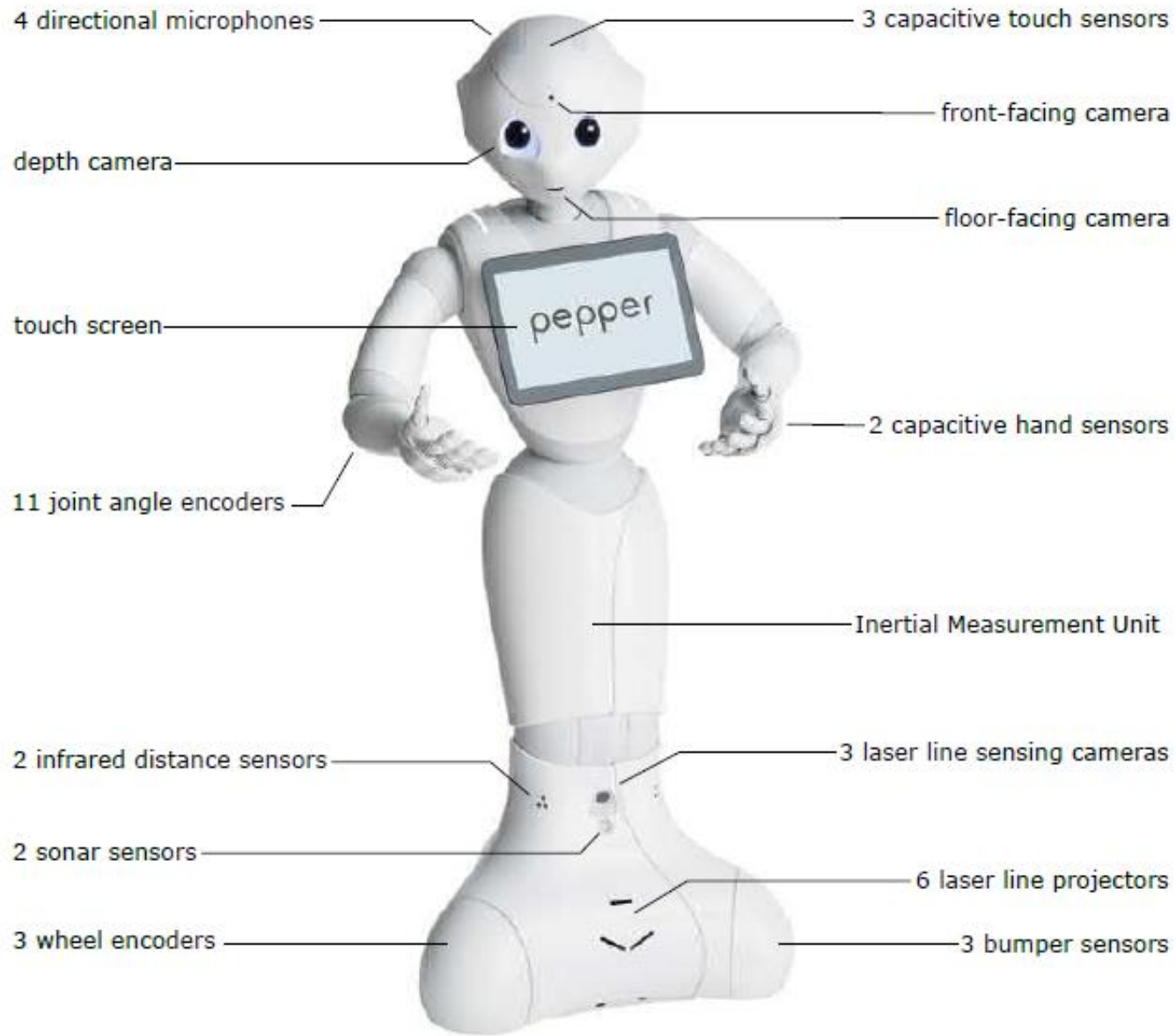

Why do we need all that?

- To make the robot look more like a human?
- No. Much less is needed for that.



Keepon by Hideki Kozima

Inertial measurement unit

- What is it?
 - 3-axis accelerometer, 3x gyroscope, magnetometer (~ compass)
 - what use is it for a humanoid robot?
 - where would you place it?



Start at ~1:00

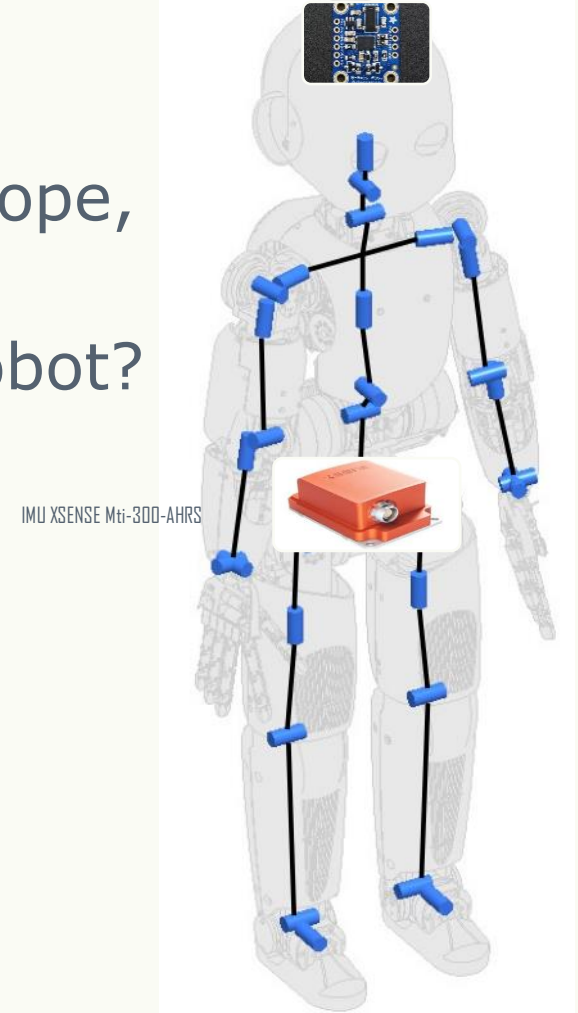

Table 5.1 Classification of sensors frequently used in robotics according to sensing objective (proprioception (PC)/exteroception (EC)) and method (active/passive)

Classification	Sensor type	Sens	A/P
Tactile sensors	Switches/bumpers	EC	P
	Optical barriers	EC	A
	Proximity	EC	P/A
Haptic sensors	Contact arrays	EC	P
	Force/torque	PC/EC	P
	Resistive	EC	P
Motor/axis sensors	Brush encoders	PC	P
	Potentiometers	PC	P
	Resolvers	PC	A
	Optical encoders	PC	A
	Magnetic encoders	PC	A
	Inductive encoders	PC	A
	Capacity encoders	EC	A
Heading sensors	Compass	EC	P
	Gyroscopes	PC	P
	Inclinometers	EC	A/P
Beacon based (position wrt an inertial frame)	GPS	EC	A
	Active optical	EC	A
	Radio frequency (RF) beacons	EC	A
Ranging	Ultrasound beacon	EC	A
	Reflective beacons	EC	A
Ranging	Capacitive sensor	EC	P
	Magnetic sensors	EC	P/A
	Camera	EC	P/A
	Sonar	EC	A
	Laser range	EC	A
	Structured light	EC	A
Speed/motion	Doppler radar	EC	A
	Doppler sound	EC	A
	Camera	EC	P
	Accelerometer	EC	P
Identification	Camera	EC	P
	Radio frequency identification RFID	EC	A
	Laser ranging	EC	A
	Radar	EC	A
	Ultrasound	EC	A
	Sound	EC	P

Christensen, H. I., & Hager, G. D. (2016). Sensing and estimation. In *Springer Handbook of Robotics* (pp. 91-112). Springer, Cham.

Sense of touch in robots

tactile sensors for fingertips

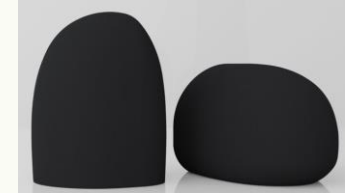

BarrettHand with Tactile Sensors P/N: B4335	
Function	Localizes pressure across palm and fingers
Quantity	96 active cells
Element Type	24 capacitive cells per sensor pad
Range	10 N/cm ²
Resolution	Palm: 0.02 N/cell; cell area 1.0 cm ²
	Finger: 0.01 N/cell; cell area 0.3 cm ²
	Fingertip: 0.01 N/cell; cell area 0.15 cm ²



large area tactile arrays



Tactile sensors for fingertips

TABLE I
TACTILE SENSING ARRAYS FOR PARTS LIKE FINGERTIPS WITH HIGH DENSITY RECEPTORS [4]–[9], [117], [166]–[178]

Year	Author	Transduction Method	Miniaturization Technique	No. of Sensing Element	Spatial Res. (mm)	Signal Condition Circuit	Sensor BW (kHz)	Range of Force ⁺ (N)/ Pressure* (kPa)	Force/ Pressure Sensitivity
1984	Raibert et al.	Resistive	Si-micromachining	6x8	~0.6	Yes ^a	—	—	—
1985	Polla et al.	Piezoelectric	Si-micromachining	8x8	0.07	Yes ^a	—	2 ⁺	5.2mV/gm
1988	Suzuki et al.	Capacitive	Si-micromachining	32x32	0.5	No	—	0.01 ⁺	0.45pF/g
1990	Sugiyama et al.	Piezoresistive	Si-micromachining	32x32	0.25	Yes ^a	60	—	0.02mV/kPa
1993	Liu et al.	Piezoresistive	Si-micromachining	4x4	1	Yes ^a	—	200*	0.032mV/kPa
1994	Audet et al.	Magnetic	Si-micromachining	—	—	Yes	—	—	—
1996	Chu et al.	Capacitive	Si-micromachining	3x3	2.2	No	—	0.01 ⁺	0.13pF/g(nf) 0.32pF/g(shf)
1996	Gray et al.	Capacitive	Si-micromachining	8x8	0.1	No	—	1.0×10 ⁻⁴⁺	20μN
1996	Kolesar et al.	Piezoelectric	Si-micromachining	8x8	0.7	Yes ^a	0.025	0.008–1.35 ⁺	—
1997	Desouza et al.	Capacitive	Si-micromachining	16x16	500dpi	No	—	—	100μN
2000	Kane et al.	Piezoresistive	MEMS on Si	64x64	0.3	Yes ^a	—	35*	1.59mV/kPa
2000	Leineweber et al.	Capacitive	Si-micromachining	8x1	0.24	Yes ^a	—	100-300*	13.5mV/kPa
2002	Castelli	Capacitive	—	8x8	>2	No	—	120*	—
2002	Hellard et al.	Optical	—	4x4	>1	No	—	—	—
2003	Wen et al.	Field Emission	MEMS on Si	8x8	1	Yes ^a	—	150*	30.1mV/kPa
2005	Choi et al.	Resistive & Piezoresistive	—	24	~1	No	—	2 ⁺	—
2006	Okha et al.	Optical	—	—	2	No	—	2 ⁺	1mN
2006	Schmidt et al.	FSR & Capacitive	—	1 _{static} 16 _{dyn.}	—	No	~0.003 35	0.05-10 ⁺ <0.01 ⁺	5mN
2006	Takao et al.	Piezoresistive	MEMS on Si	6x6	0.42	Yes ^a	—	0.021–0.176 ⁺	0.5–1V/N
2009	Dahiya et al.	Piezoelectric	Si-micromachining	32	1	Yes	5	5*	0.5V/N

^aElectronics circuitry (partly) on the sensing array; nf: normal force; shf: shear force.

Dahiya, R. S., Metta, G., Valle, M., & Sandini, G. (2010). Tactile sensing—from humans to humanoids. *IEEE Transactions on Robotics*, 26(1), 1-20.

Tactile sensors – transduction principle

“electrical”

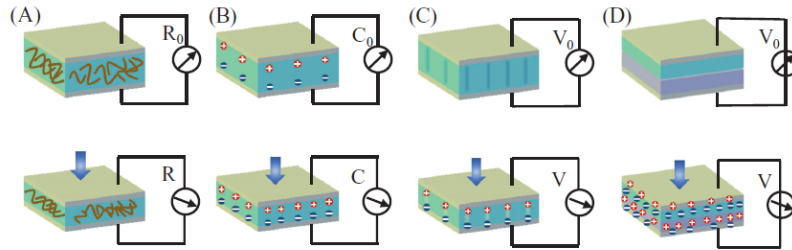
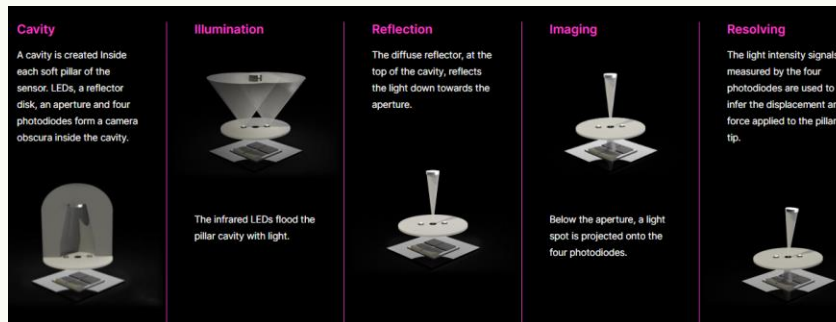

FIGURE 2 Working mechanisms of flexible pressure sensors. A) R represents the measurement parameter of piezoresistance pressure sensors, and R_0 represents the initial resistance; B) C represents the measurement parameter of capacitance pressure sensors, and C_0 represents the initial capacitance; C) V represents the measurement parameter of piezoelectricity pressure sensors, and the initial voltage V_0 is 0 under no pressure D) V represents the measurement parameter of triboelectricity pressure sensors, and the initial voltage V_0 is 0 under no pressure

Tang, R., Lu, F., Liu, L., Yan, Y., Du, Q., Zhang, B., ... & Fu, H. (2021). Flexible pressure sensors with microstructures. *Nano Select*, 2(10), 1874-1901.

optical



<https://contactile.com/novel-optical-sensing-technology/>

magnetic

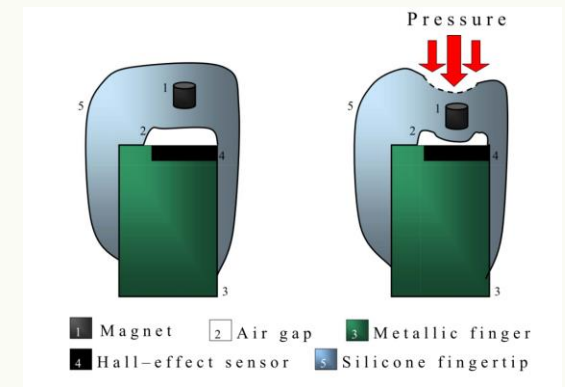

Jamone, L., Natale, L., Metta, G., & Sandini, G. (2015). Highly sensitive soft tactile sensors for an anthropomorphic robotic hand. *IEEE Sensors Journal*, 15(8), 4226-4233.

Magnetic tactile sensors

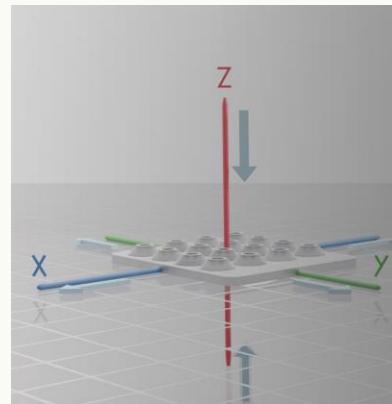
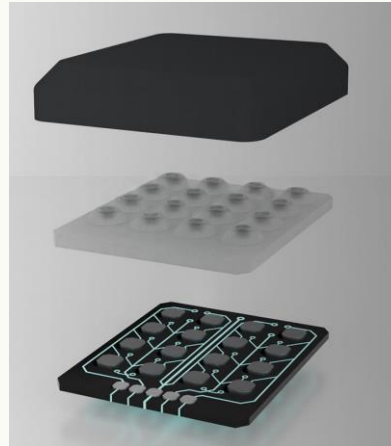
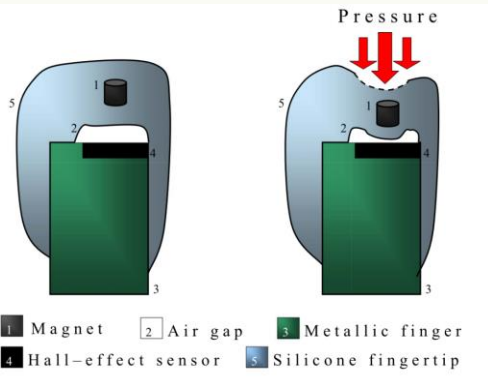

Jamone, L., Natale, L., Metta, G., & Sandini, G. (2015). Highly sensitive soft tactile sensors for an anthropomorphic robotic hand. *IEEE Sensors Journal*, 15(8), 4226-4233.

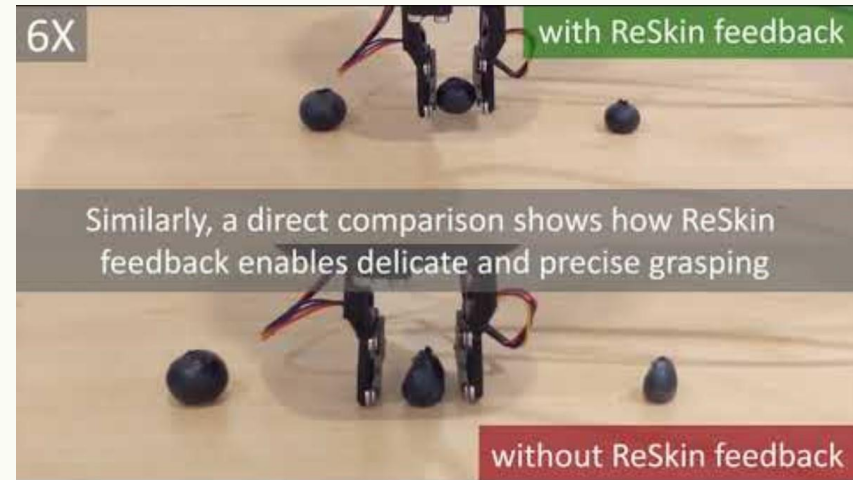

<https://reskin.dev/>
https://youtu.be/SxT_G-lm_CA?feature=shared

<https://www.xelarobotics.com/tactile-sensors>

Optical tactile sensors

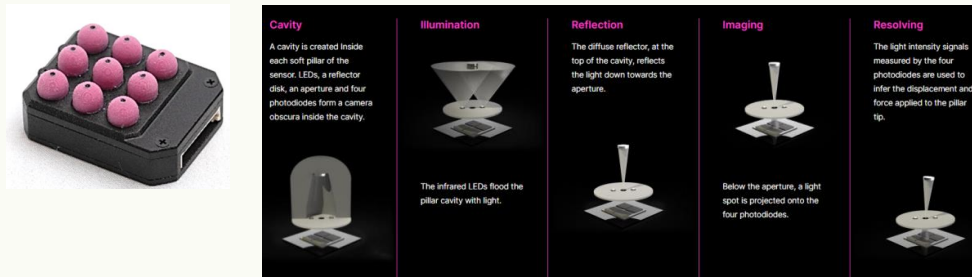

<https://contactile.com/novel-optical-sensing-technology/>



TABLE I
COMPARISON OF DIGIT, GELSIGHT, AND GELSLIM
* CONSIDERING THE MANUFACTURING OF 1000 PIECES

	DIGIT (Ours)	Fingertip GelSight [11]	GelSlim [12]
Size [mm]	20x27x18	35x60x35	50x205x20
Weight [g]	20	NA	NA
Sensing field [mm]	19x16	18x14	30x40
Image Resolution	640x480	1920x1080	640x480
Image FPS	60	30	60
Cost components [\$]	15*	~30	NA

A B C D E F G

Fig. 2. Exploded view of a single DIGIT sensor. A) elastomer, B) acrylic window, C) snap-fit holder, D) lighting PCB, E) plastic housing, F) camera PCB, G) back housing.

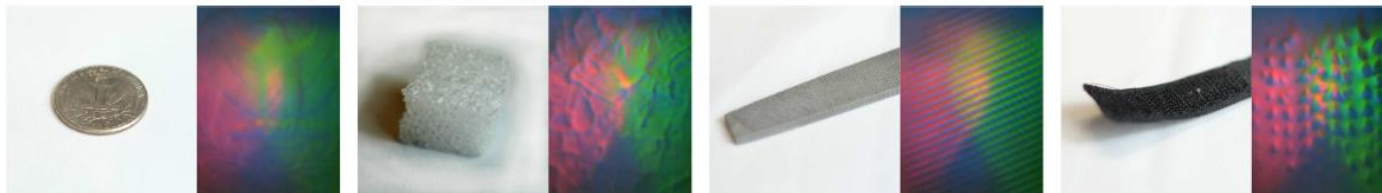
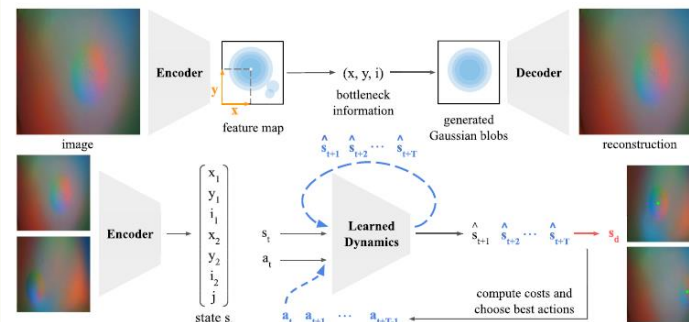

Fig. 3. Object under test and corresponding raw measurements taken using DIGIT. The measurements taken from DIGIT clearly capture sub-millimeters structures.

- 😊 trending now
- 😊 high spatial resolution
- 😞 postprocessing
- 😞 machine learning needed for interpretation
- 😞 latency

Lambeta, M., Chou, P. W., Tian, S., Yang, B., Maloon, B., Most, V. R., ... & Calandra, R. (2020). Digit: A novel design for a low-cost compact high-resolution tactile sensor with application to in-hand manipulation. *IEEE Robotics and Automation Letters*, 5(3), 3838-3845.

Robots with whole-body electronic skin

- It seems quite clear why cameras or microphones are useful...
- Why skin?
 - Whole-body contact sensing and regulation
 - For HRI:
 - Safety
 - Contact detection and localization
 - Skin on whole body => safety of whole body
 - Social interaction



Large-scale robot skin in our lab



iCub humanoid ~
4000 taxels



Nao humanoid
retrofitted with "iCub
skin" – 970 taxels



UR 10
manipulator with
Airskin

Tactile sensors for large areas

TABLE II
TACTILE SENSING ARRAYS FOR PARTS LIKE LARGE AREA SKIN WITH LOW DENSITY OF RECEPTORS [10], [11], [156], [157], [180], [192]–[198]

Year	Author	Transduction Method	Miniaturization Technique	No. of Sensing Element	Spatial Res. (mm)	Signal Condition Circuit ^a	Sensor BW ^b (kHz)	Range of Force ⁺ (N)/ Pressure* (kPa)	Force/ Pressure Sensitivity
1989	Cheung et al.	Optical	—————	16	—	Yes	—	—	—
1992	Domenici et al.	Piezoelectric	On Polyimide	6x7	2.5	No	—	—	—
1998	Um et al.	Optical	—————	1000	25	Yes	—	—	—
2004	Someya et al.	FSR	Organic FET	32x32	2.54	No	0.003	30*	—
2004	Weiss et al.	Resistive	—————	3x8	4	No	—	—	—
2005	Engel et al.	Resistive	MEMS on Polymer	25	~5	No	—	—	—
2005	Shan et al.	Piezoresistive	MEMS on Si	4x4	10	No	—	2 ⁺	228mV/N(nf) 34mV/N(shf)
2006	Heo et al.	Optical	—————	3x3	5	No	—	5N	1mN
2006	Kim et al.	Strain Gauge	MEMS on Polymer	4x4	2.5	No	—	0.6+	0.52V/N(nf) 0.25V/N(shf)
2006	Ohmura et al.	Optical	—————	8x4	~30	No	—	—	—
2008	Maggiali et al.	Capacitive	Flexible PCB	12	10	Yes	—	—	—
2008	Mukai et al.	Piezoresistive	Flexible PCB	8x8	18	Yes	0.1	128*	—

^aElectronics circuitry (partly) on the sensing array; nf: normal force; shf: shear force.

Dahiya, R. S., Metta, G., Valle, M., & Sandini, G. (2010). Tactile sensing—from humans to humanoids. *IEEE Transactions on Robotics*, 26(1), 1-20.

Capacitive robot skin

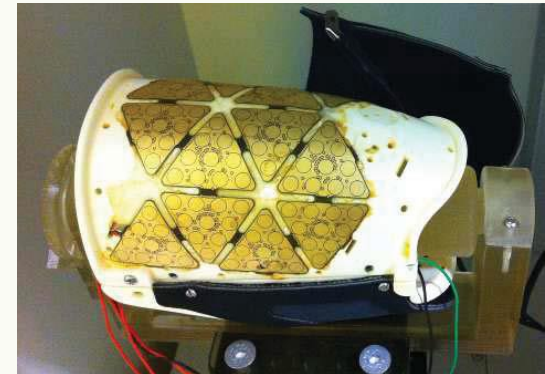
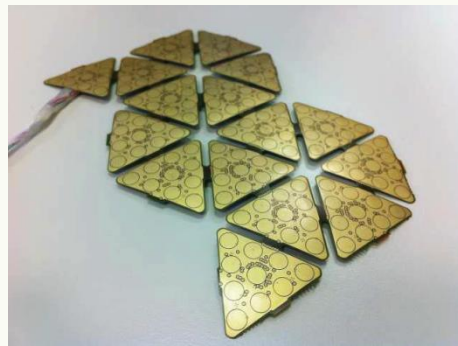
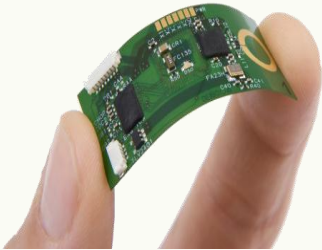
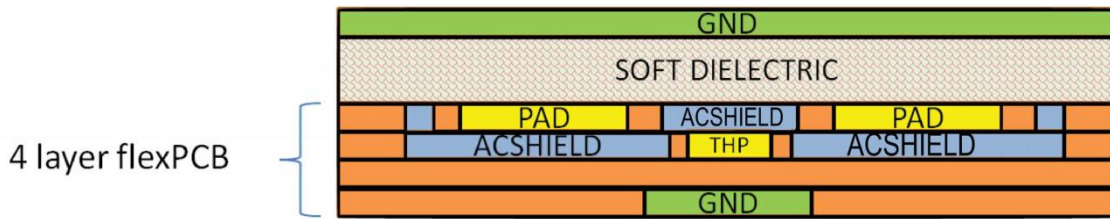
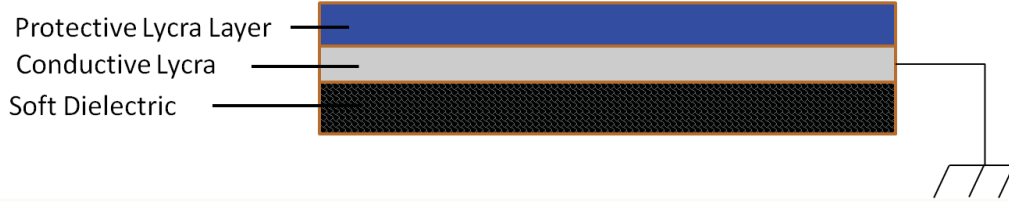

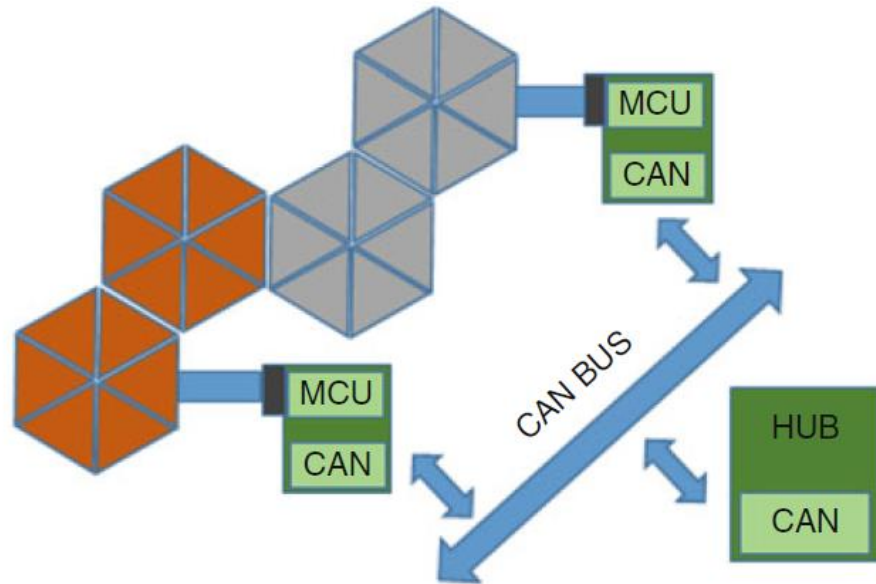
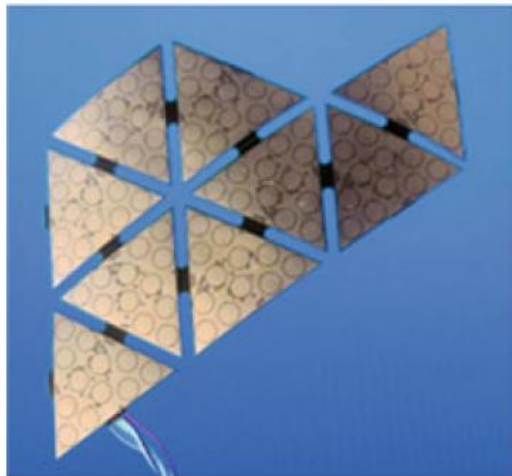
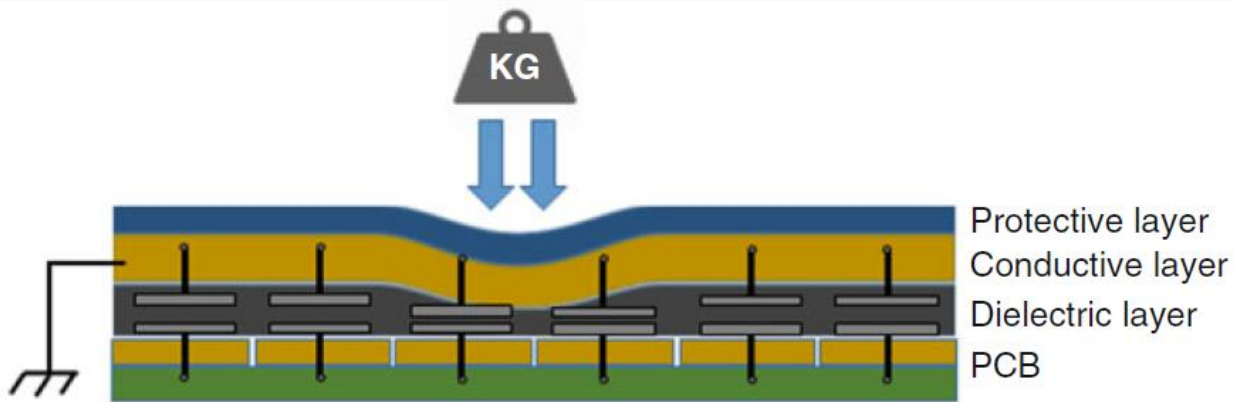

Fig. 8 The iCub skin. *Top*: a schematic representation of the three layers that form the set of capacitors each providing pressure information. *Bottom*: details of the triangular elements and how they are interconnected to form a mesh of sensors that can be read using CAN bus interface

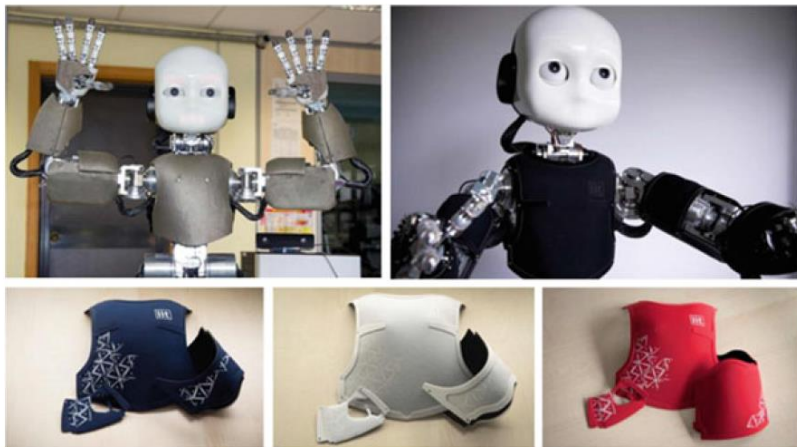

Fig. 9 The first version of the skin used a silicone layered as dielectric, covered with conductive Lycra (*top left*). In the second version of the skin, these layers were replaced by a sandwich of three layers made of fabrics glued with industrial techniques. Among the advantages of this solution is the fact that the production of the fabric is automated and more reliable. The picture on the *top right* shows the latest version of the skin. The figures on the *bottom* show possible customizations in different colors

Natale, L., Bartolozzi, C., Nori, F., Sandini, G., & Metta, G. (2019). iCub. In Goswami, A., & Vadakkepat, P. (Eds.): *Humanoid robotics: A reference*. Springer. pp. 291-323.

Capacitive sensors

- popular solution

- ☺ high sensitivity
- ☺ relatively low power consumption
- ☺ simple device architecture and readout electronics

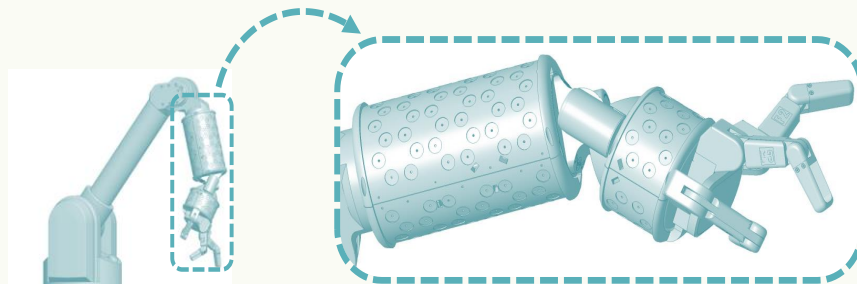

Maiolino, P.; Maggiali, M.; Cannata, G.; Metta, G. & Natale, L. (2013), 'A flexible and robust large scale capacitive tactile system for robots', *Sensors Journal, IEEE 13(10), 3910--3917*.

Human Touch Recognition and Classification

Goal: To use robot skin feedback:

- to capture complex contact events between the robot and the environment including objects and humans
- discriminate voluntary contacts from unplanned ones

Processing pipeline

- Contact with the robot
- 3D mapping of measurements
- Tactile image generation (3D to 2D) and classification
- Hand tactile image segmentation
- Back-projection to 3D

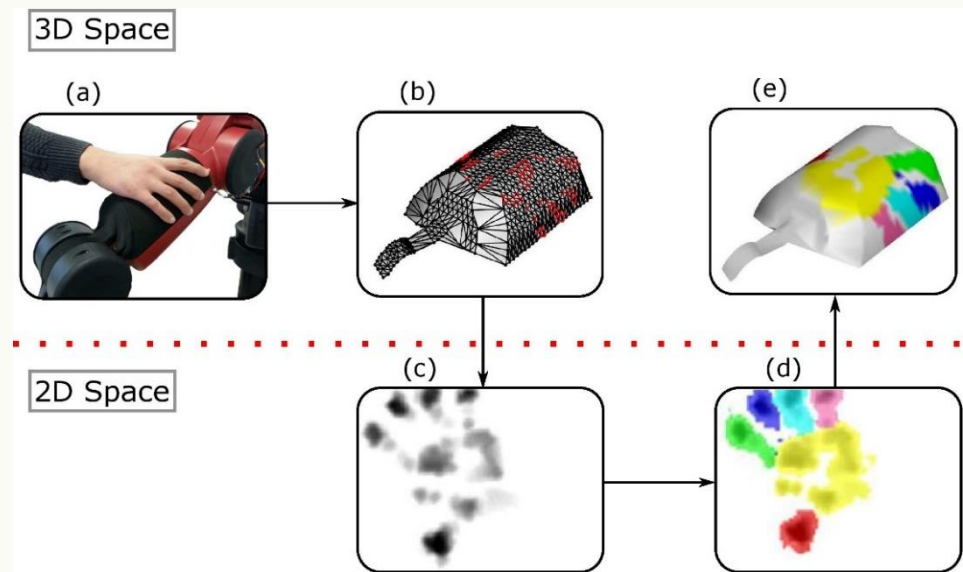

A. Albini, G. Cannata, "Pressure Distribution Classification and Segmentation of Human Hands in Contact with the Robot Body, *The International Journal of Robotics Research* (2020)

Slide – courtesy Giorgio Cannata, Uni. Genova

Results

Key results:

- Processing pipeline
- Hand vs. non-hand contact classification
- Hand contact segmentation
- Robustness analysis
- Portability analysis

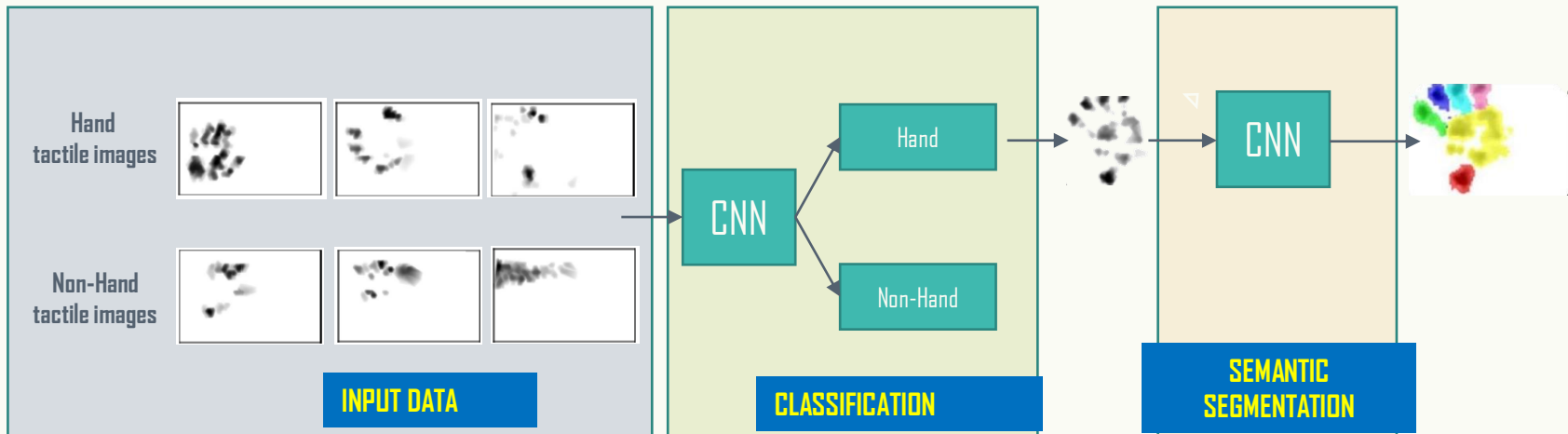

A. Albini, G. Cannata, "*Pressure Distribution Classification and Segmentation of Human Hands in Contact with the Robot Body*, *The International Journal of Robotics Research*, (2020)

Slide – courtesy Giorgio Cannata, Uni. Genova

Fiber Bragg Grating sensors

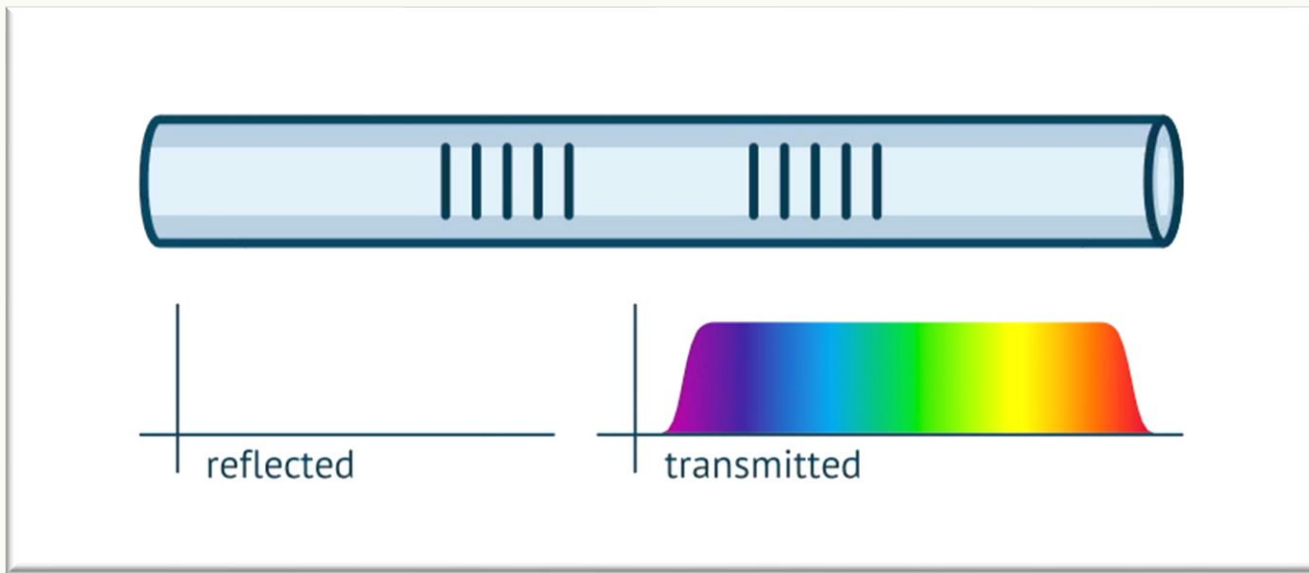

Low wiring encumbrance

Immunity to EM

High sensitivity

Multiplexing

Animation source: <https://fisens.com/fbg-sensors/>

Slide – courtesy Calogero M. Oddo, SSSA Pisa

The Artificial Skin: The forearm

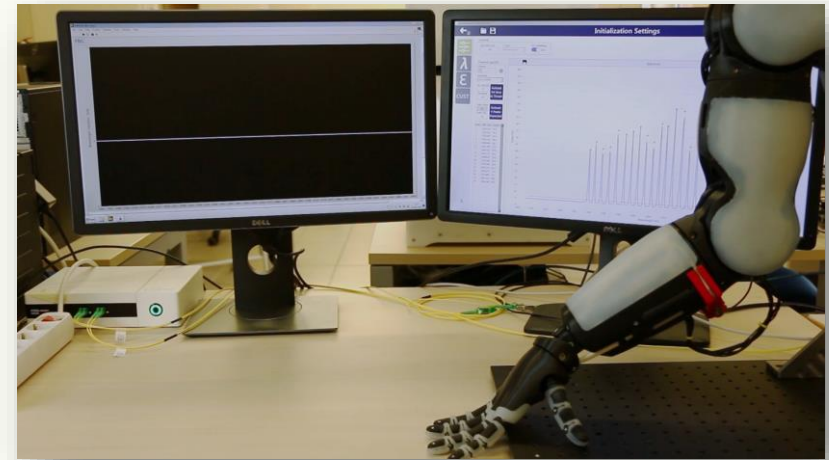
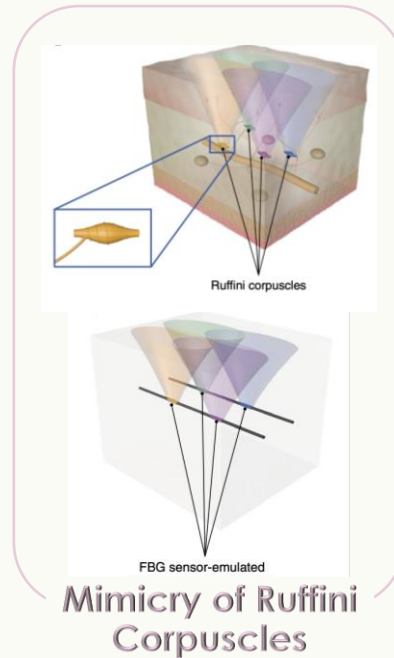

Distributed Sensors
Soft **One/few wire/s**
Large Area **Lightweight**

Slide – courtesy Calogero M. Oddo, SSSA Pisa

The Artificial Skin: AI model

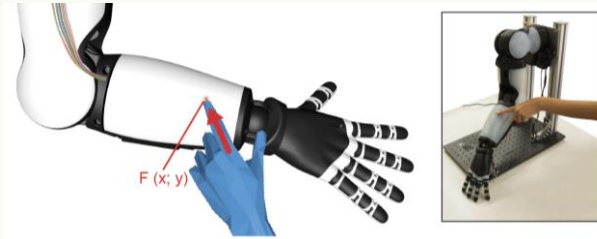

Touch sensing means to identify the applied force and to localize the contact

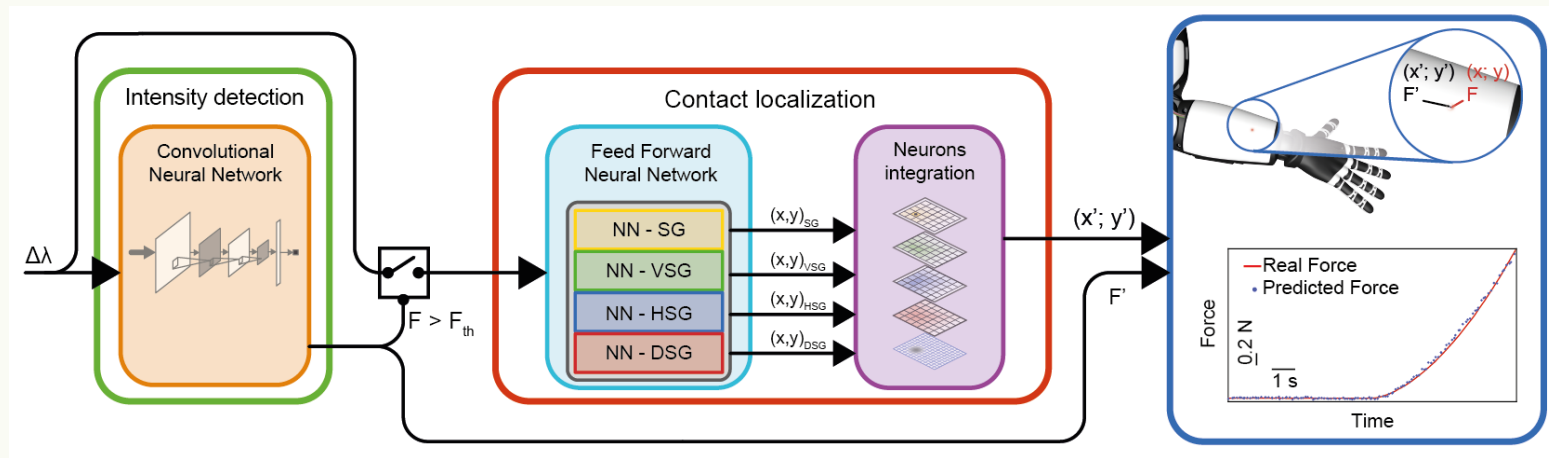
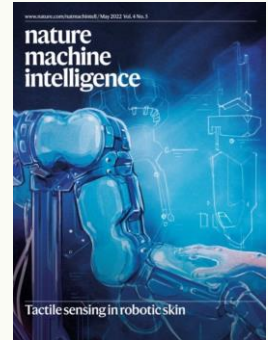

Massari, L., Fransvea, G., D'Abbraccio, J., Filosa, M., Terruso, G., Aliperta, A., ... & Oddo, C. M. (2022). Functional mimicry of Ruffini receptors with Fiber Bragg Gratings and Deep Neural Networks enables a bio-inspired large-area tactile sensitive skin. *Nature Machine Intelligence* 2022

Slide – courtesy Calogero M. Oddo, SSSA Pisa

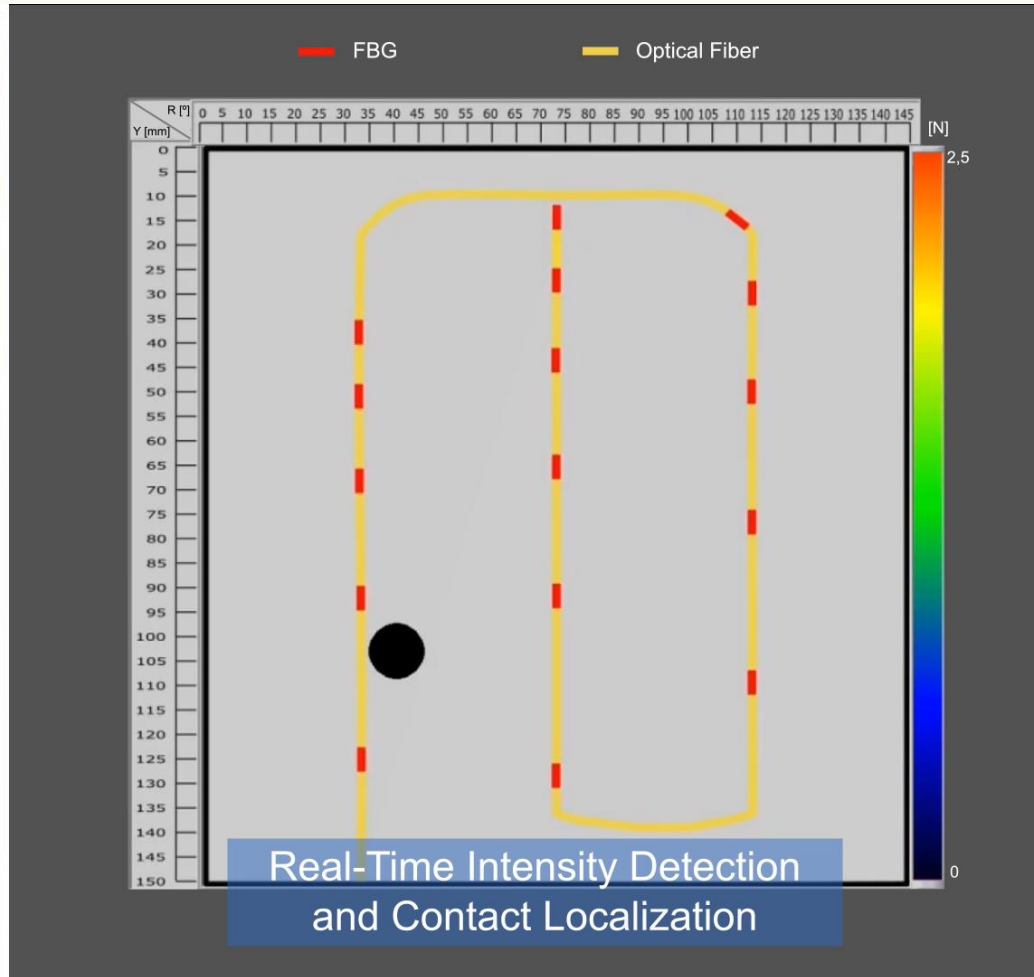
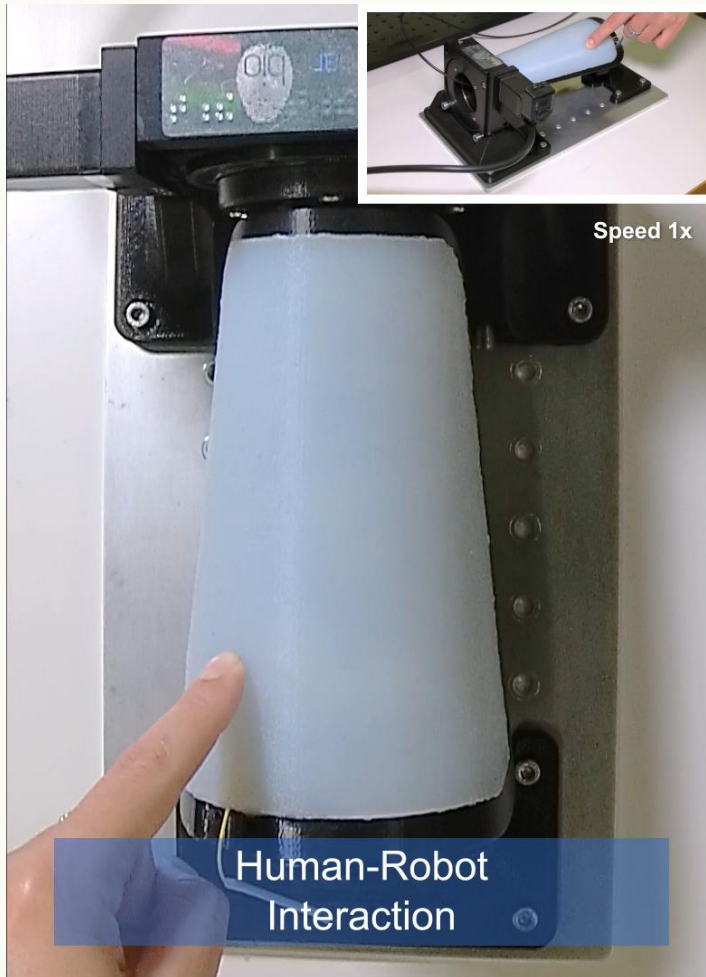

Slide – courtesy Calogero M. Oddo, SSSA Pisa

Multimodal robot skin

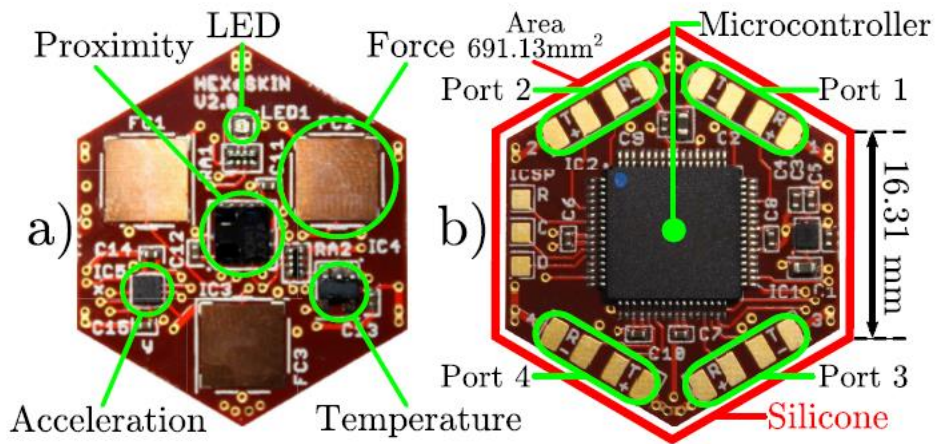

Fig. 2. Robot skin developed at Institute for Cognitive Systems. (a) Sensors mounted on every cell. (b) Microcontroller and dimensions of the cell electronics encapsulated in silicone material.

Gordon Cheng,
Technical University of Munich

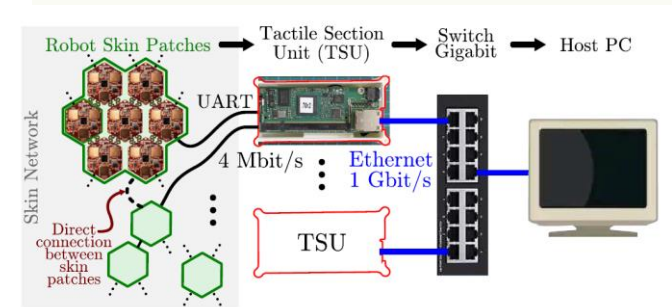

Fig. 3. Robot skin network and communication interface to a workstation.



Cheng, G., Dean-Leon, E., Bergner, F., Olvera, J. R. G., Leboutet, Q., & Mittendorf, P. (2019). A comprehensive realization of robot skin: Sensors, sensing, control, and applications. *Proceedings of the IEEE*, 107(10), 2034-2051.

Multimodal robot skin

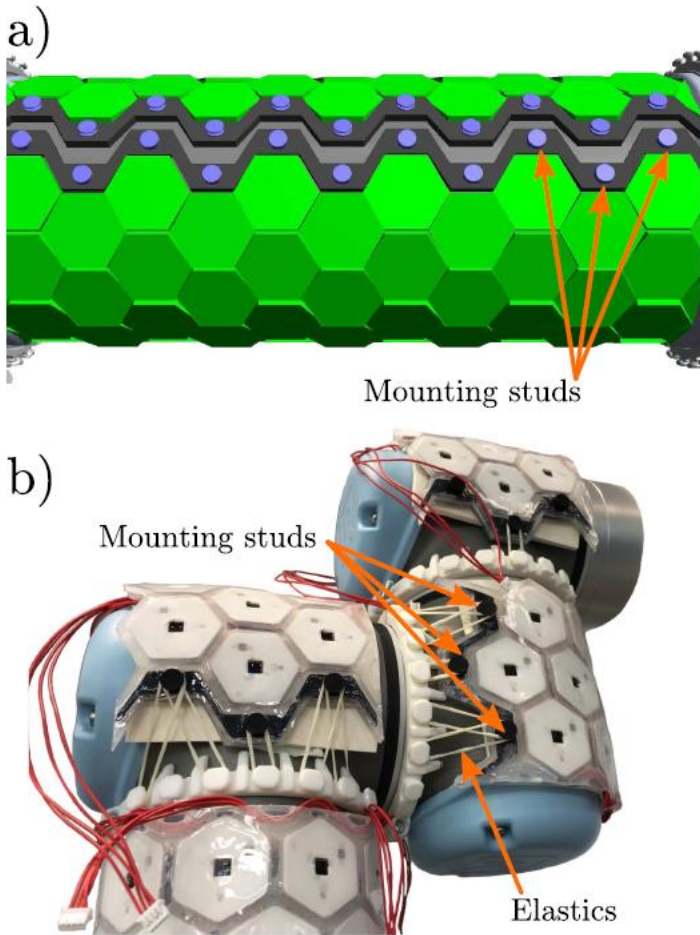
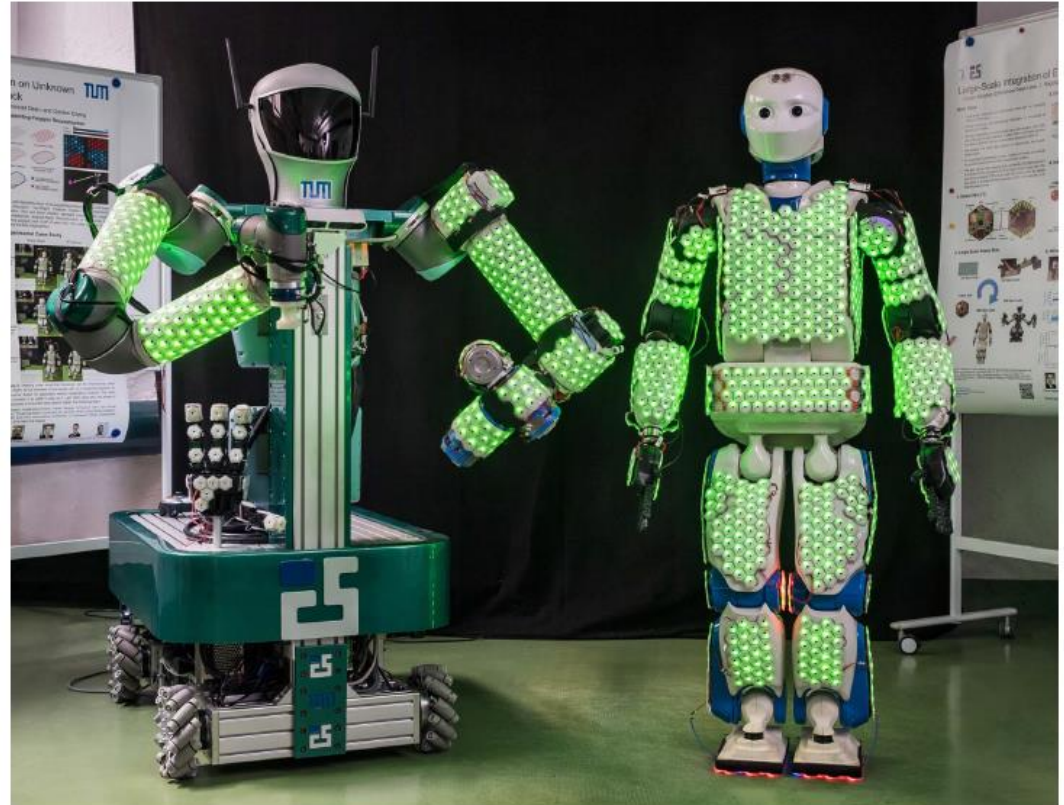

Fig. 7. Anchor mechanism for the robot skin. The mounting studs allow fast deployment of the skin patches on to the robot. (a) CAD design. (b) On the real robot.



Cheng, G., Dean-Leon, E., Bergner, F., Olvera, J. R. G., Leboutet, Q., & Mittendorf, P. (2019). A comprehensive realization of robot skin: Sensors, sensing, control, and applications. *Proceedings of the IEEE*, 107(10), 2034-2051.

Multimodal robot skin

- How would you use the skin?
- How would you calibrate it (spatial skin calibration)?

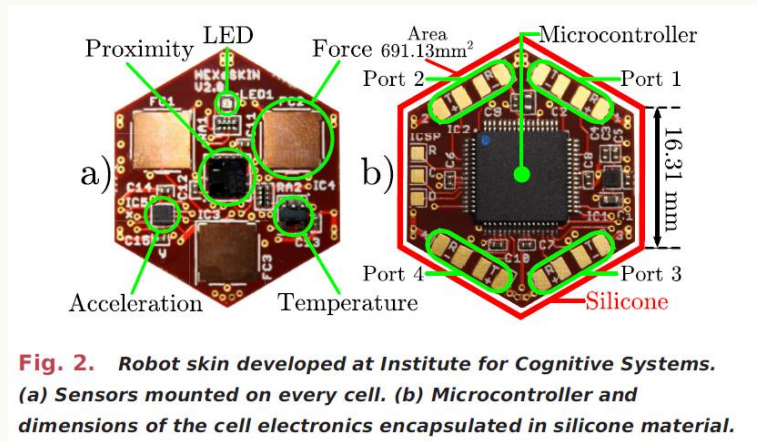

Cheng, G., Dean-Leon, E., Bergner, F., Olvera, J. R. G., Leboutet, Q., & Mittendorf, P. (2019). A comprehensive realization of robot skin: Sensors, sensing, control, and applications. *Proceedings of the IEEE*, 107(10), 2034-2051.

Multimodal robot skin

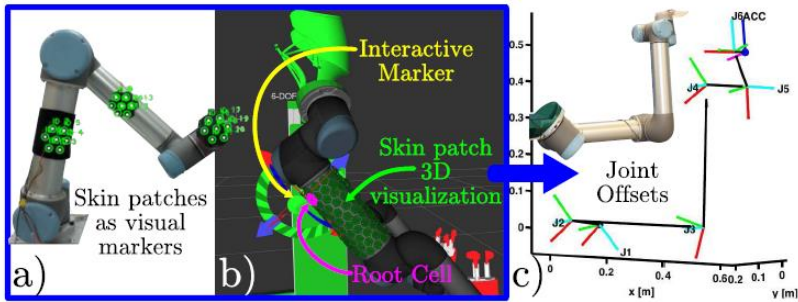

Fig. 5. (a) Localization of robot skin patches (root cells) in the robot body frames (rT_j) using (a) embedded LEDs in the skin cells to transform the skin patches into visual markers. (b) Manual localization of the skin patches using an intuitive GUI with interactive markers. (c) D-H-like kinematic parameters can be obtained using the skin information and the local transformations from the skin patches to the robot body frames.

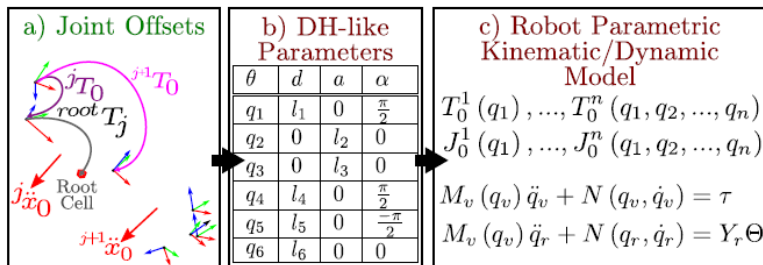

Fig. 6. Parametric kinematic and dynamic modeling. (a) Self-acquired kinematic information of the skin patches can be used to obtain robot kinematic parameters. These parameters can be represented as (b) D-H like parameters, which in turn, can be used to obtain (c) analytic models of the robot.

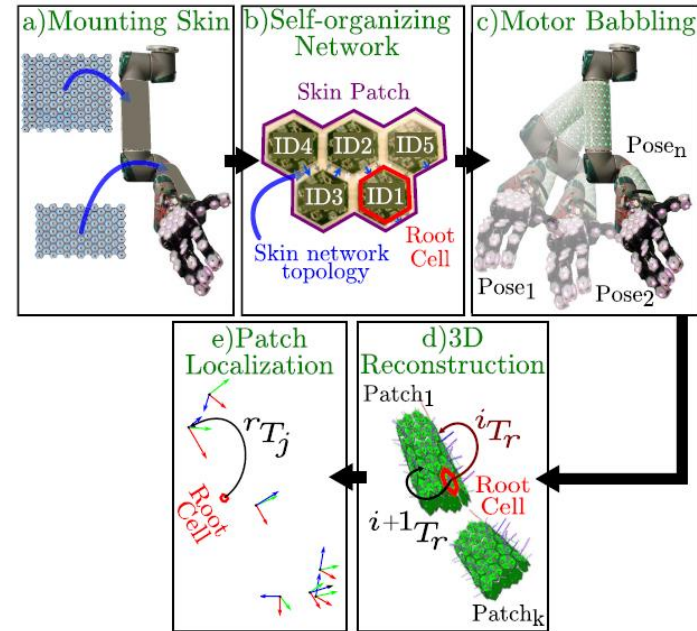
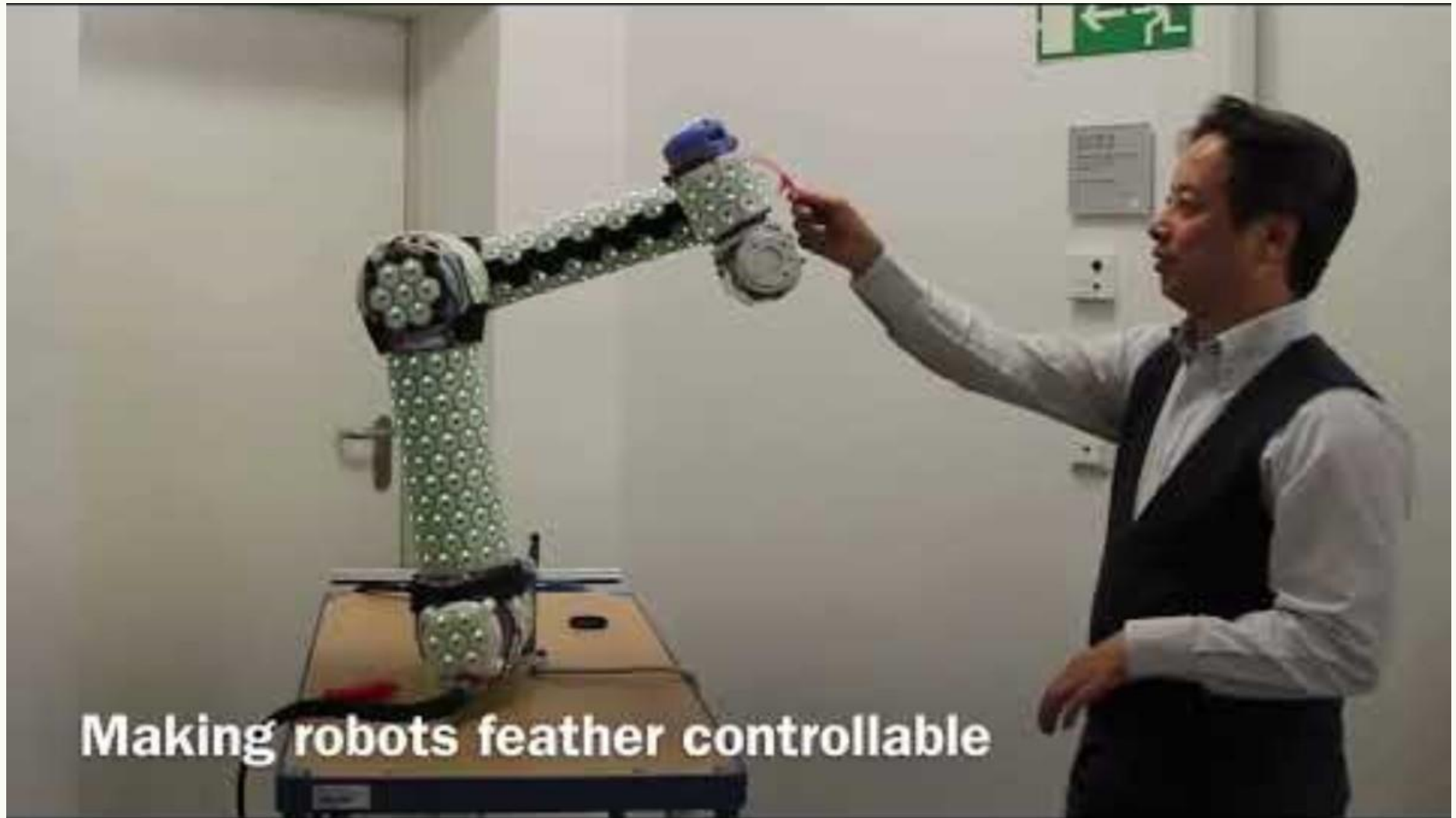

Fig. 4. Self-configuration and self-localization of the robot skin system. Once the skin patches are mounted on the robot, the approach starts with a skin cell network exploration, then a 3-D reconstruction of the robot surface is performed, and finally, a skin patch localization is obtained. (a) Mounting skin. (b) Self-organizing network. (c) Motor babbling. (d) 3-D reconstruction. (e) Patch localization.

Cheng, G., Dean-Leon, E., Bergner, F., Olvera, J. R. G., Leboutet, Q., & Mittendorf, P. (2019). A comprehensive realization of robot skin: Sensors, sensing, control, and applications. *Proceedings of the IEEE*, 107(10), 2034-2051.

Multimodal robot skin



https://youtu.be/uhYENEC53ha?si=7wAHpc0u7_8DZufy

Collaborative robots with protective skin



Spatial calibration of whole-body artificial skin on humanoid robots

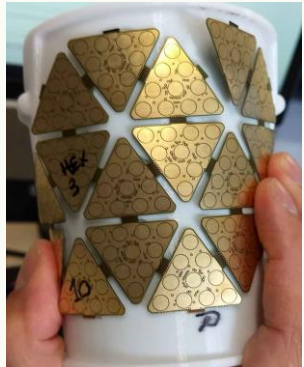
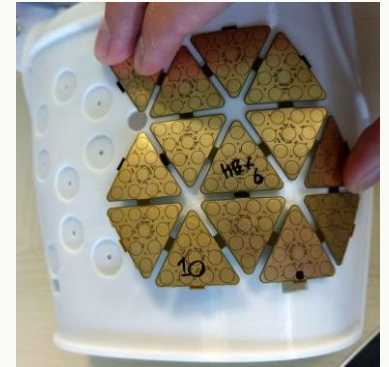
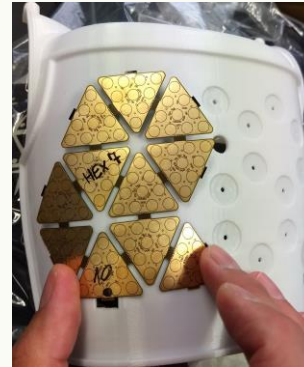

self-contact with finger
(3 parameters for finger)

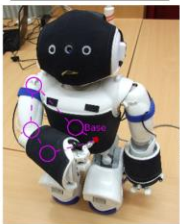
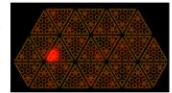

self-contact skin-on-skin

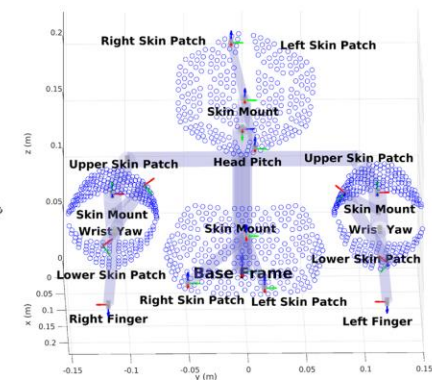
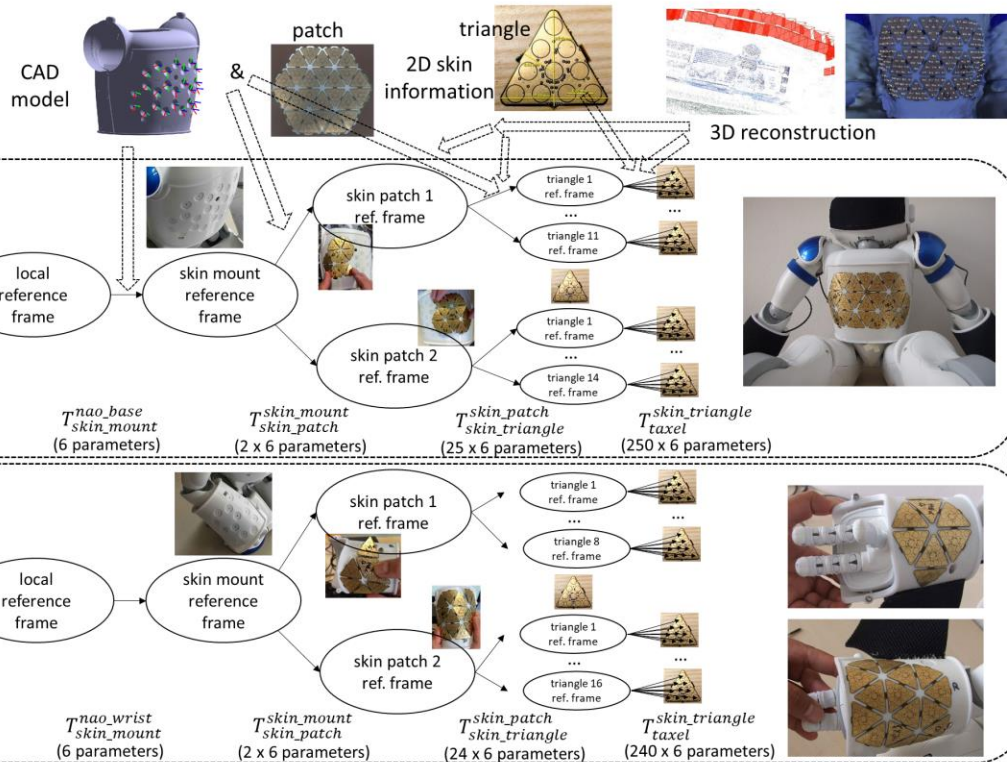
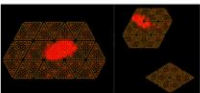

Rustler, L.; Potocna, B.; Polic, M.; Stepanova, K. & Hoffmann, M. (2021), Spatial calibration of whole-body artificial skin on a humanoid robot: comparing self-contact, 3D reconstruction, and CAD-based calibration, in 'Humanoid Robots (Humanoids), IEEE-RAS International Conference on', pp. 445-452.

CAD-based calibration

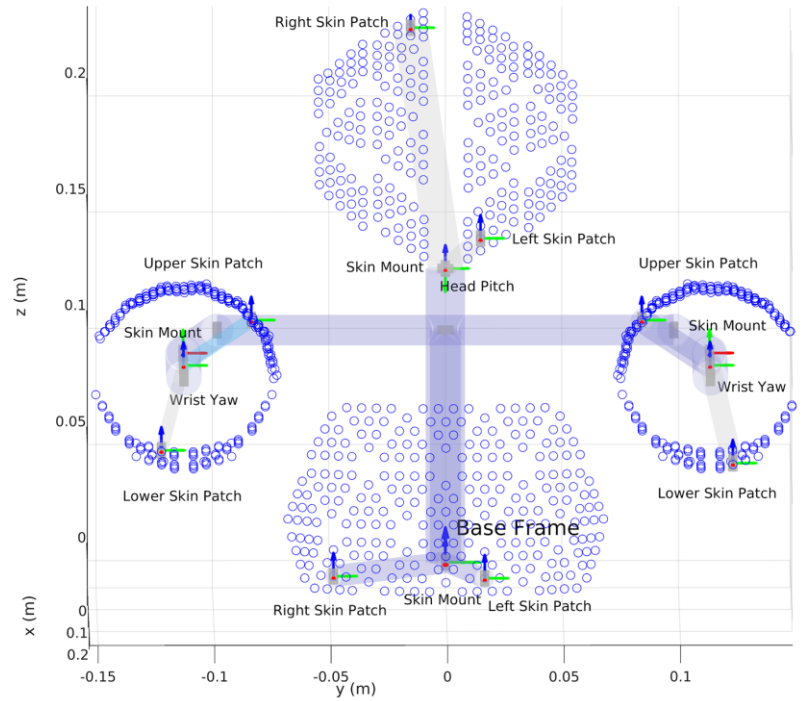
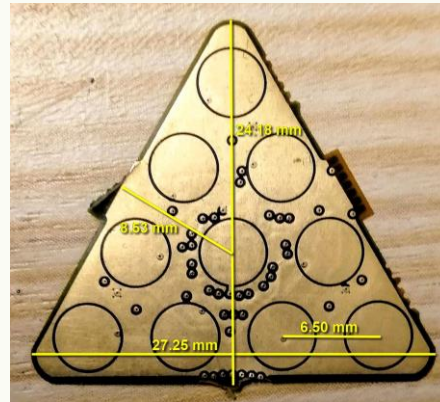
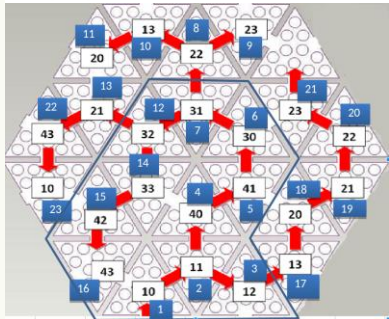
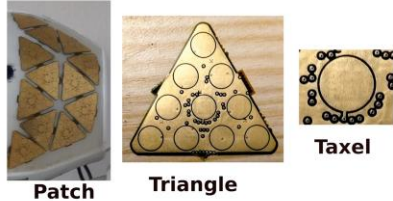
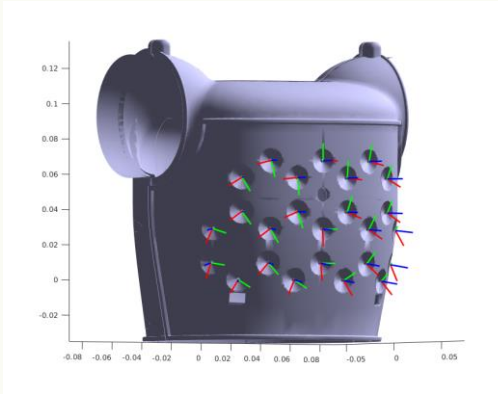
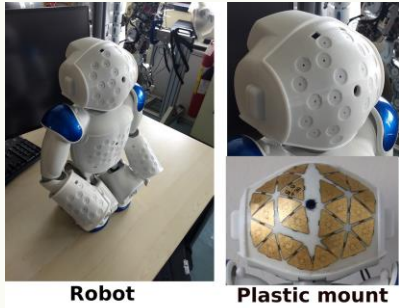

3D reconstruction

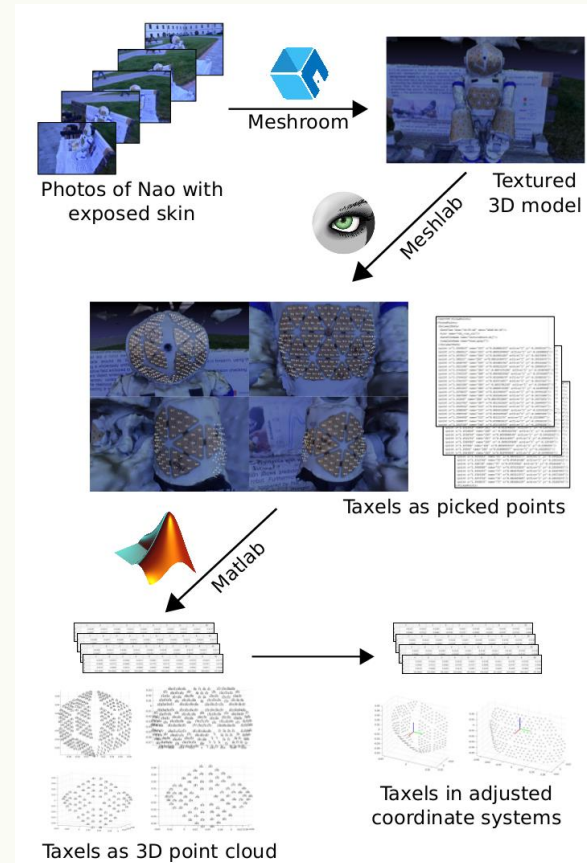
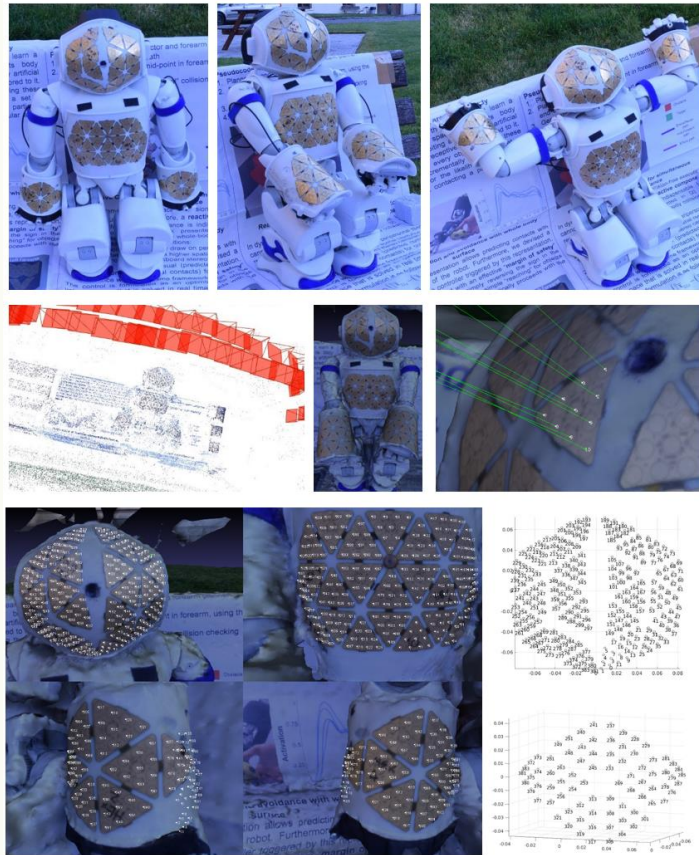

Results - CAD and 3D reconstruction

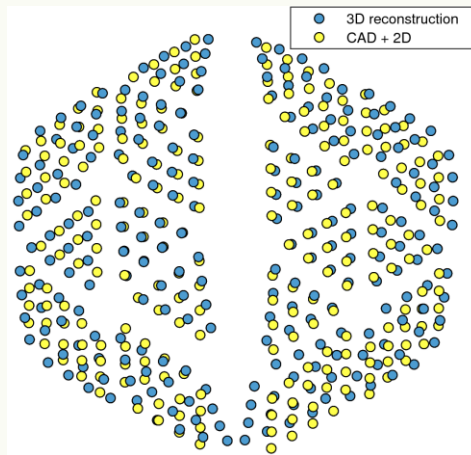

Self-touch

"skin on skin"

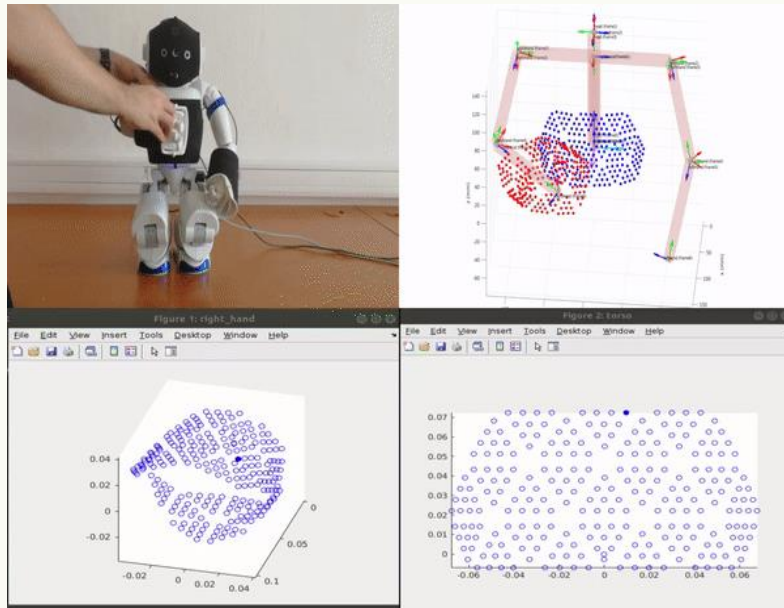

"artificial finger"



Results - perturbations

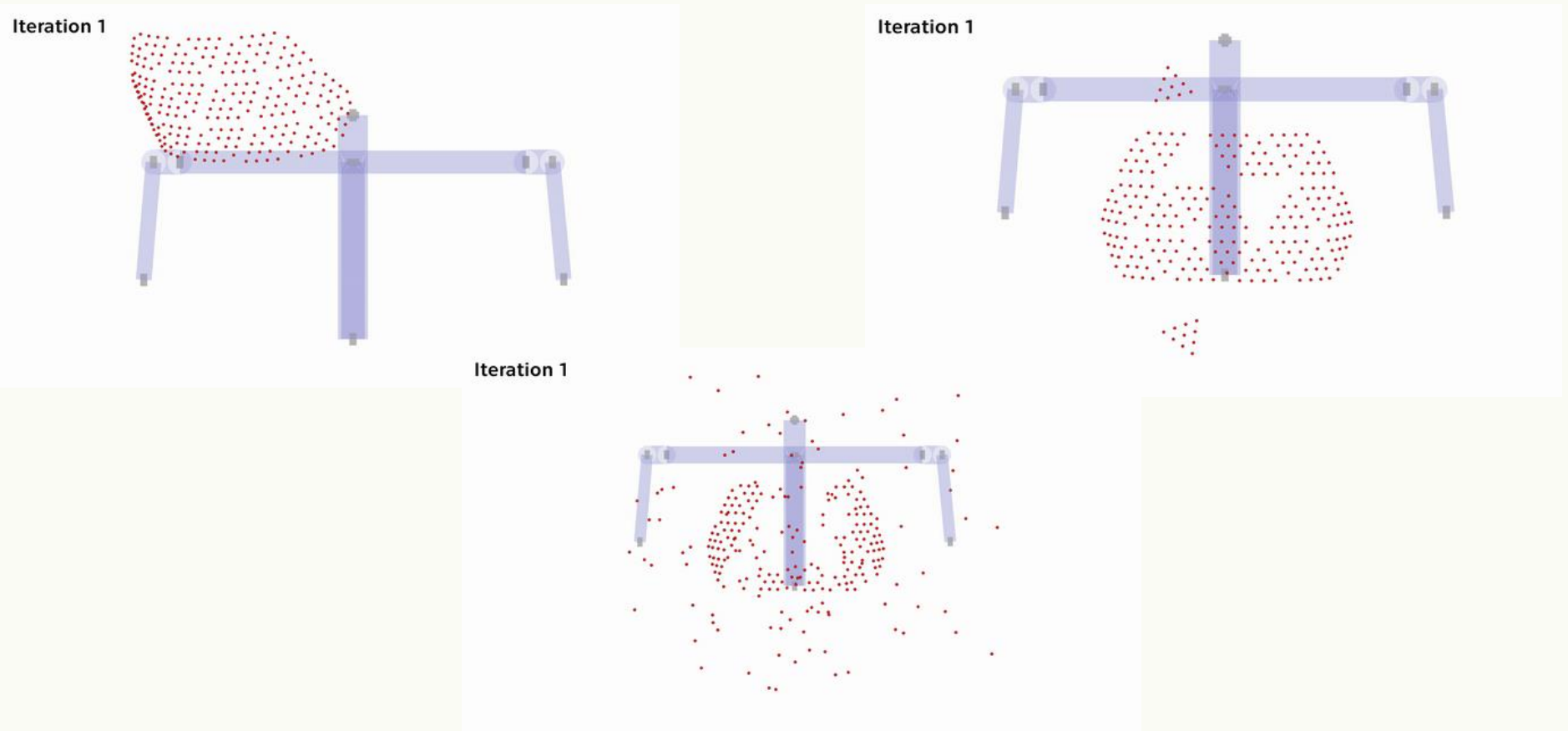

Results - 2D input

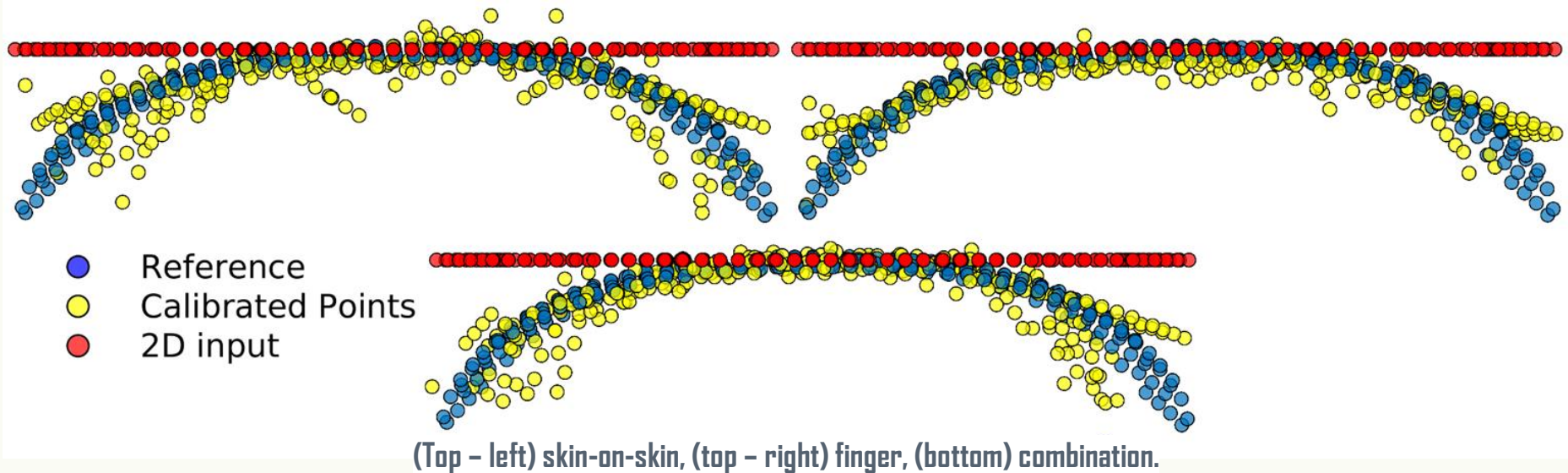

Large-area sensitive skins - challenges

- resilience
- manufacturing
- mechanics
- sensorics
- electronics
- energetics
- information processing
- transport

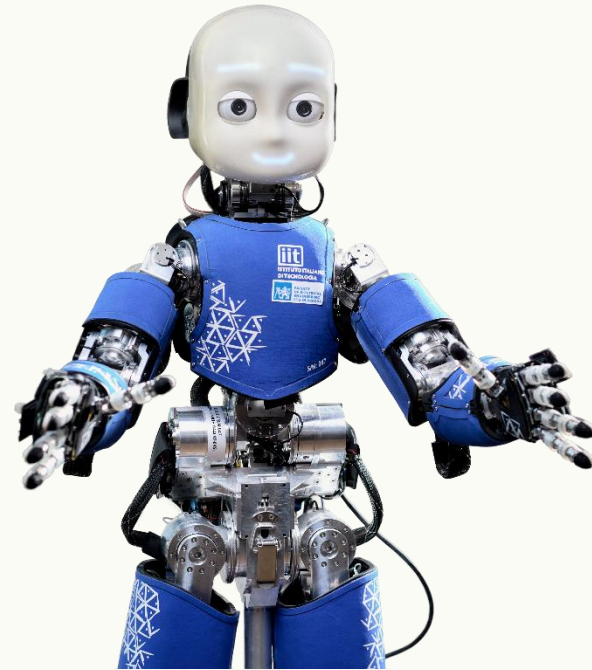

~ 4000 tactile receptors

Dahiya, R., Yogeswaran, N., Liu, F., Manjakkal, L., Burdet, E., Hayward, V., & Jörntell, H. (2019). Large-area soft e-skin: The challenges beyond sensor designs. *Proceedings of the IEEE*, 107(10), 2016-2033.

Tactile Sensing—From Humans to Humanoids

Ravinder S. Dahiya, *Member, IEEE*, Giorgio Metta, Maurizio Valle, *Member, IEEE*, and Giulio Sandini

Abstract—Starting from human “sense of touch,” this paper reviews the state of tactile sensing in robotics. The physiology, coding, and transferring tactile data and perceptual importance of the “sense of touch” in humans are discussed. Following this, a number of design hints derived for robotic tactile sensing are presented. Various technologies and transduction methods used to improve the touch sense capability of robots are presented. Tactile sensing, focused to fingertips and hands until past decade or so, has now been extended to whole body, even though many issues remain open. Trend and methods to develop tactile sensing arrays for various body sites are presented. Finally, various system issues that keep tactile sensing away from widespread utility are discussed.

Index Terms—Cutaneous sensing, extrinsic sensing, humanoid robots, robotic skin, tactile sensing, touch sensing system.

I. INTRODUCTION

ROBOTIC devices, limited to the structured environment of manufacturing plants until few years ago, are slowly entering into human life in one form or another. This has led to emergence of interaction and learning issues—more so for

the skin on the hands of a group of volunteers, demonstrates the difficulty of maintaining a stable grasp of objects [2]. The movements become inaccurate and unstable when the “sense of touch” is lost. In another, rather unusual, experiment performed on astronauts at the International Space Station, the vibrotactile cues provided via “sense of touch” are found to be highly indicative of the direction and spatial disorientation [3]. “Sense of touch” allows assessing object properties, e.g., size, shape texture, temperature, etc. It is needed to detect slip, to roll an object between the fingers without dropping it, to develop awareness of the body, and, hence, to differentiate “me” from “not me.” Thus, absence of the “sense of touch” (for that matter, any sensing modality) would widen the gap between what is sensed and what is perceived.

As in humans, touch sensing in humanoid robots would help in understanding the interaction behaviors of a real-world object, which depend on its weight and stiffness, on how its surface feels when touched, how it deforms on contact, and how it moves

What is similar or different? Discussion.

Human receptors for touch

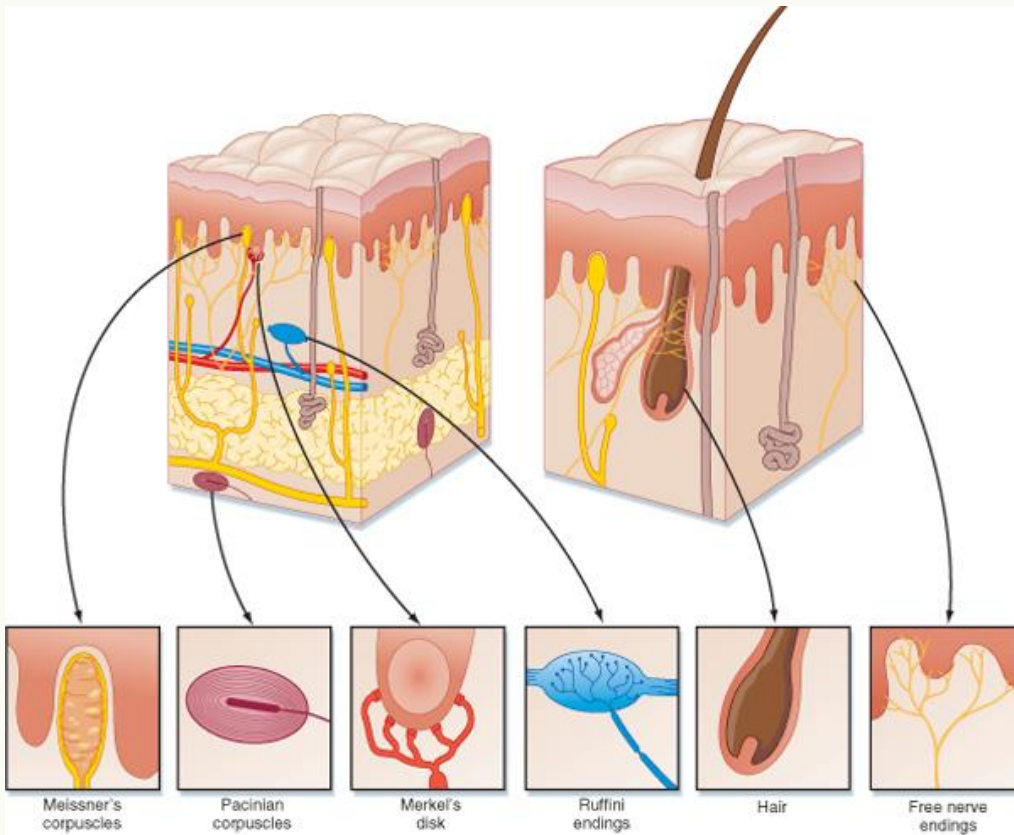

Aristotle (400 B.C.) wondered whether touch was one sense or many...

A



B

Ref : Koeppen &
Stanton : Berne &
Levy Physiology,
6th Edition

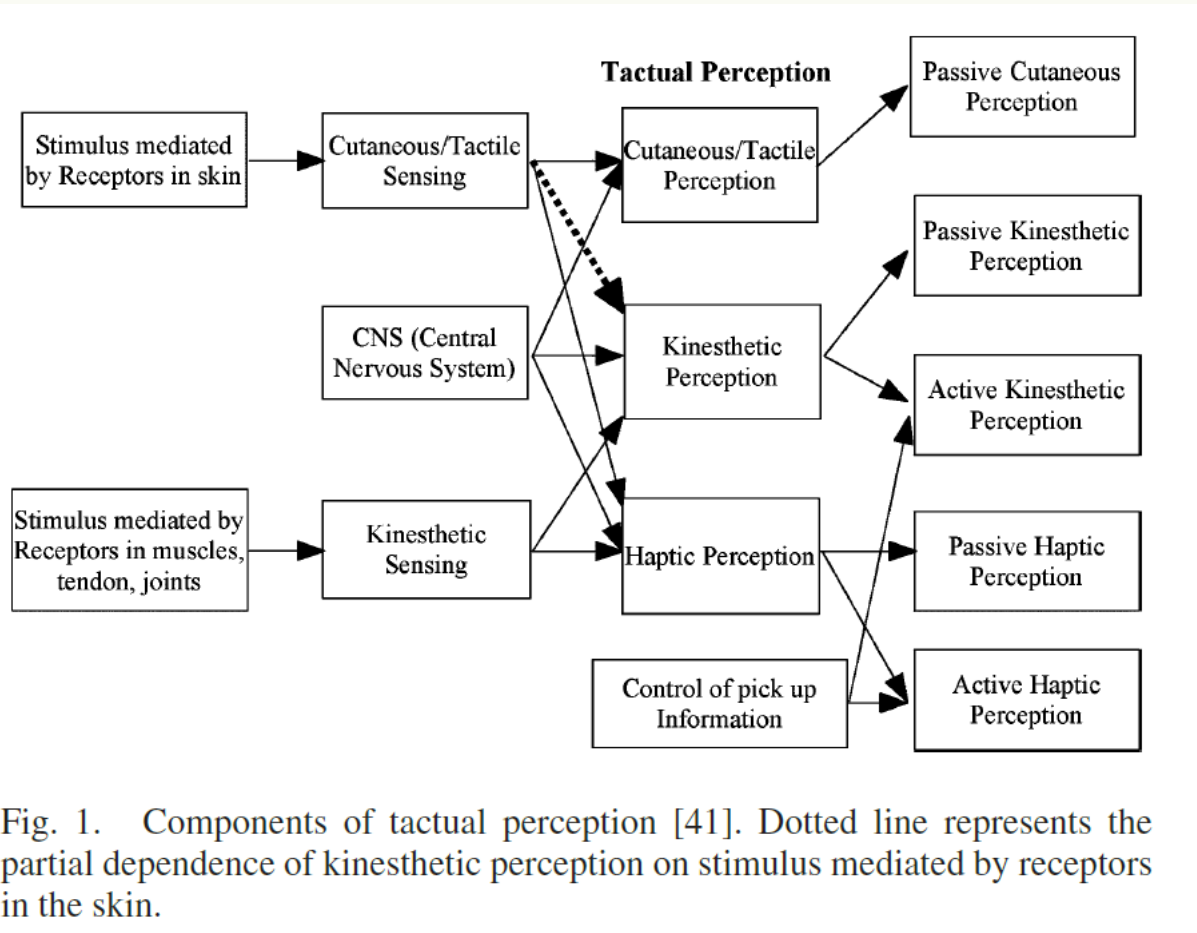
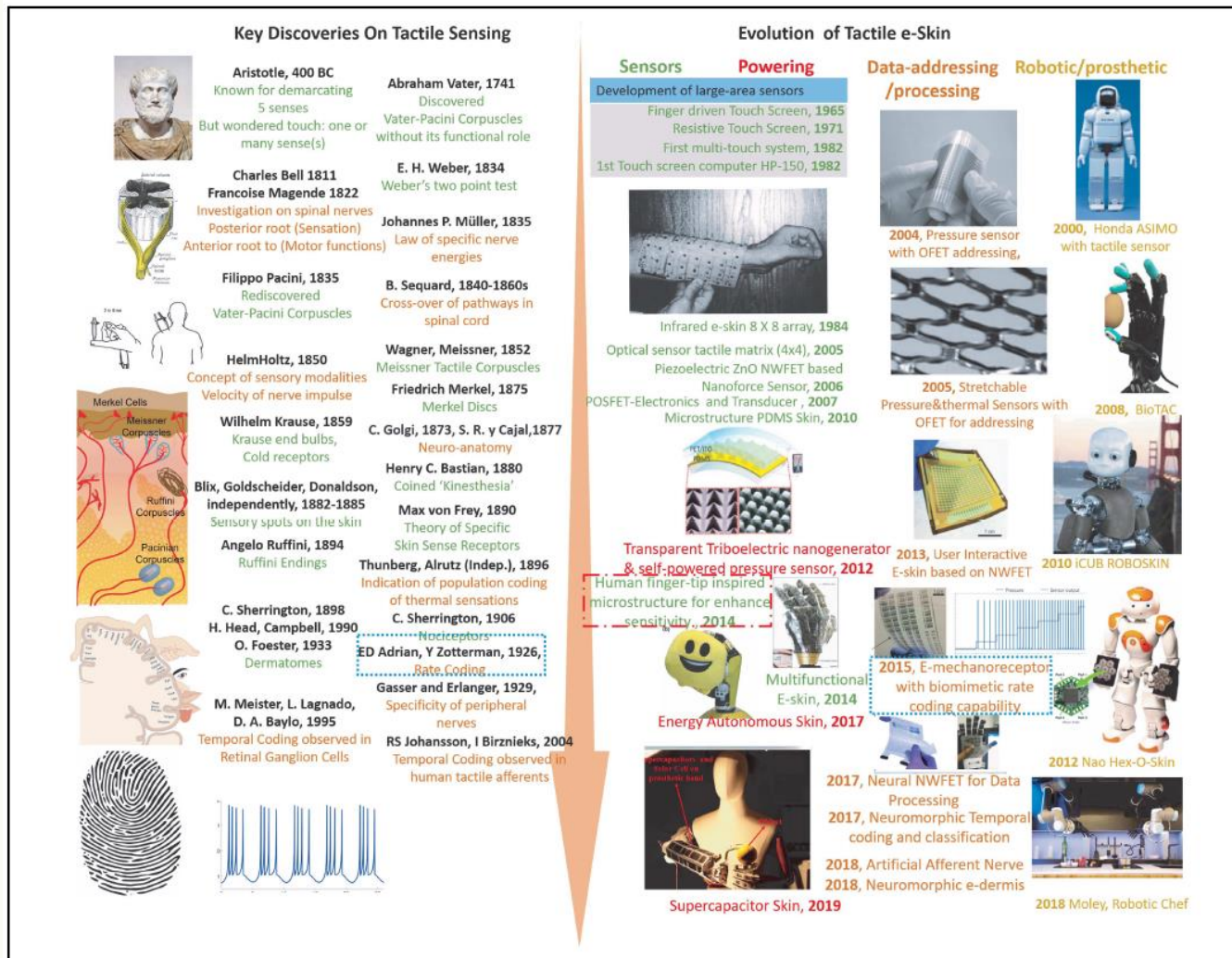

Fig. 1. Components of tactual perception [41]. Dotted line represents the partial dependence of kinesthetic perception on stimulus mediated by receptors in the skin.

Dahiya, R. S., Metta, G., Valle, M., & Sandini, G. (2010). Tactile sensing—from humans to humanoids. *IEEE Transactions on Robotics*, 26(1), 1-20.

Human tactile sensing and "e-skin" timeline



Dahiya, R. S., Metta, G., Valle, M., & Sandini, G. (2010). Tactile sensing—from humans to humanoids. *IEEE Transactions on Robotics*, 26(1), 1-20.

Human vs. robot sense of touch - discussion

- Mechanical state of the skin, which is a deformable solid, requires an infinite number of coordinates to be described (\sim 3-D continuous medium).
- Yet, touch sensors generate scalar outputs \sim tremendous dimensionality reduction.
- "Tactile image" – is limited.
- Touch requires the availability of sensors with different properties.
- \rightarrow embedding sensors in elastic material at different depths
- Power consumption is a critical issue.
 - 1000 iCub tactile sensors \sim 8 W. 4000 tactile sensors \sim 32 W.
 - Human skin \sim 45 000 mechanoreceptors distributed in the skin + thermoreceptors + C-fiber system.
- \rightarrow Event-based and neuromorphic processing of touch

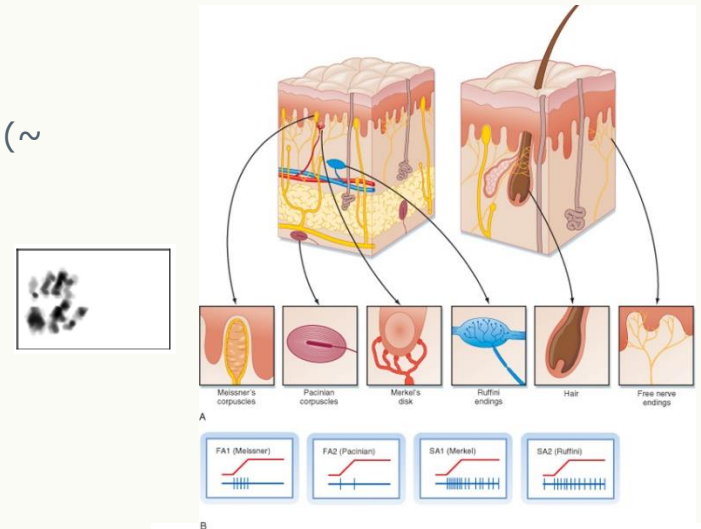

SCIENCE ROBOTICS | REVIEW

SENSORS

Neuro-inspired electronic skin for robots

Fengyuan Liu^{1†}, Sweety Deswal^{1†}, Adamos Christou¹, Yulia Sandamirskaya², Mohsen Kaboli^{3,4}, Ravinder Dahiya^{1*}

Touch is a complex sensing modality owing to large number of receptors (mechano, thermal, pain) nonuniformly embedded in the soft skin all over the body. These receptors can gather and encode the large tactile data, allowing us to feel and perceive the real world. This efficient somatosensation far outperforms the touch-sensing capability of most of the state-of-the-art robots today and suggests the need for neural-like hardware for electronic skin (e-skin). This could be attained through either innovative schemes for developing distributed electronics or repurposing the neuromorphic circuits developed for other sensory modalities such as vision and audio. This Review highlights the hardware implementations of various computational building blocks for e-skin and the ways they can be integrated to potentially realize human skin-like or peripheral nervous system-like functionalities. The neural-like sensing and data processing are discussed along with various algorithms and hardware architectures. The integration of ultrathin neuromorphic chips for local computation and the printed electronics on soft substrate used for the development of e-skin over large areas are expected to advance robotic interaction as well as open new avenues for research in medical instrumentation, wearables, electronics, and neuroprosthetics.

Copyright © 2022
The Authors, some
rights reserved;
exclusive licensee
American Association
for the Advancement
of Science. No claim
to original U.S.
Government Work

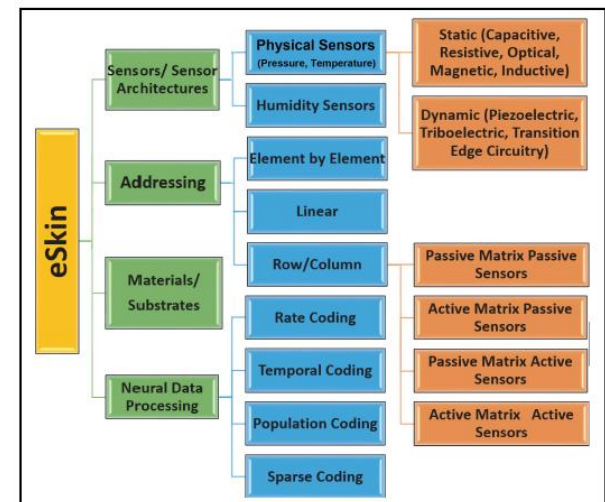
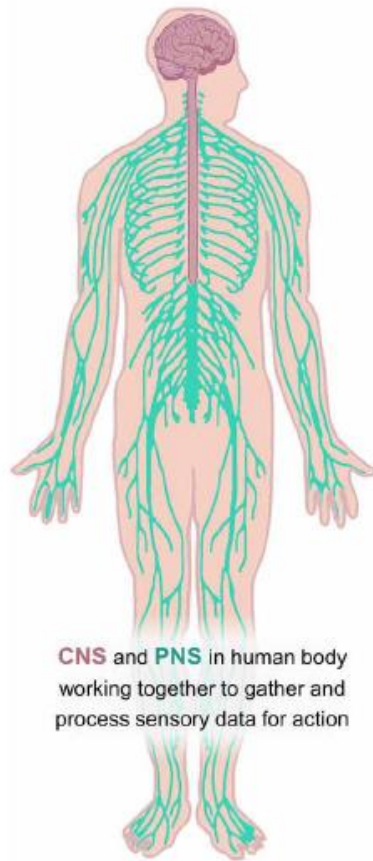

Fig. 3. Various components of e-skin including sensors and the interfacing methods to read the sensory data.

Discussion on this slide after:

Dahiya, R., Yogeswaran, N., Liu, F., Manjakkal, L., Burdet, E., Hayward, V., & Jörintell, H. (2019). Large-area soft e-skin: The challenges beyond sensor designs. *Proceedings of the IEEE*, 107(10), 2016-2033.



2020s
Energy generating skin



2010s
Multi-sensory rigid PCB placed on flexible substrate

2010s
Flexible skin on printed circuit boards



2000s
Tactile sensor sheet

1990s
Skin with the shelf sensors

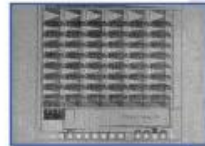

1980s
Robotic hand with joint sensors



Large-area tactile skin in robotics mainly focusing on distributed touch sensors over the whole body



Liu, F., Deswal, S., Christou, A., Sandamirskaya, Y., Kaboli, M., & Dahiya, R. (2022). Neuro-inspired electronic skin for robots. *Science robotics*, 7(67), eab17344.

Resources

- Ch. 7 Sensors in Correll, N., Hayes, B., Heckman, C., Roncone, A. (2022). Introduction to Autonomous Robots: Mechanisms, Sensors, Actuators, and Algorithms, MIT Press (forthcoming). [FREELY AVAILABLE]. <https://github.com/Introduction-to-Autonomous-Robots/Introduction-to-Autonomous-Robots>
- Dahiya, R. S., Metta, G., Valle, M., & Sandini, G. (2010). Tactile sensing—from humans to humanoids. *IEEE Transactions on Robotics*, 26(1), 1-20.
- Cheng, G., Dean-Leon, E., Bergner, F., Olvera, J. R. G., Leboutet, Q., & Mittendorfer, P. (2019). A comprehensive realization of robot skin: Sensors, sensing, control, and applications. *Proceedings of the IEEE*, 107(10), 2034-2051.